

Fracture Wall Panels

Premier Collection

Fracture panels are an acoustic wall treatment precision carved with a beveled groove into a series of directional linework designs. Install these panels together to create spectacular, full-scale patterns of rich color, depth, shadow, and texture.

Specifications

Surface	Wall
Material	FilaSorb™ polyester felt
Weight	12mm, 0.49 lb./ft ² (±10%) 24mm, 0.98 lb./ft ² (±10%)
Standard Sizes	48" W x 108" H <i>Custom sizes available</i>

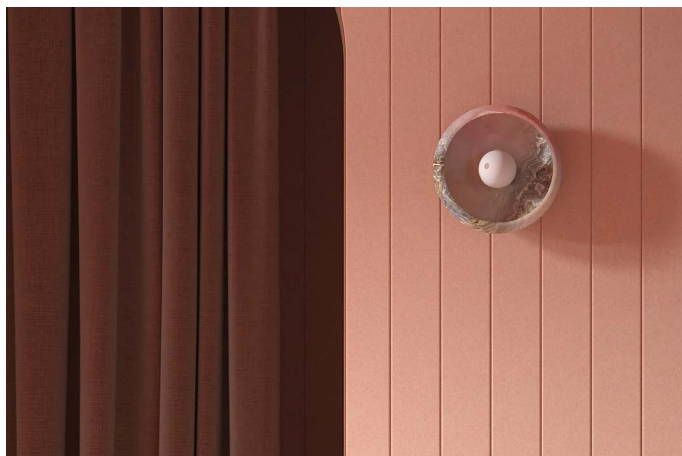

Fracture, Fineline Wall Panels in Flamingo

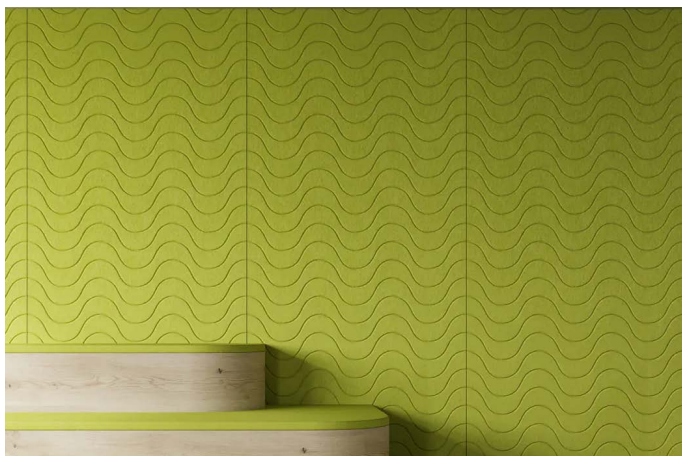

Fracture, Wavelength Wall Panels in Wasabi

Technical

NRC Rating	12mm* 0.45, no air gap 0.54, 12mm air gap 0.64, 20mm air gap 24mm* 0.60, no air gap*
Fire Test	ASTM E84, Class A CAN/ULC-S102 Flame spread index: 15 Smoke developed index: 200
Water Sorption	ASTM C1104-2019 (A Modified) Water sorbed by weight: 0.20% (based on a 12mm thick panel)
Colorfastness	ISO 105-B02, 6-7

* Test results available upon request

Details

Lead Time	3 – 6 weeks
Origin	Manufactured and assembled in the US
Warranty	Product: 20 years* Colorfastness: 20 years*

* Conditions apply

Environmental

Recycled Content	Minimum 60%
Energy	Generated using 40% solar energy
Indoor Air Quality	VOC less than/equal to 0.5mg/m ³
Recyclable	100%*
Certifications	Health Product Declaration (HPD)** Environmental Product Declaration Declare Certification - LBC Red List Free (third-party verified) SCS Global Indoor Advantage Gold

* PET is recyclable through participating partners.

** HPD only applies to 12mm thickness.



© The Health Product Declaration® logo is a registered trademark of HPD Collaborative.



For questions or additional product information, visit acoufelt.com or call 800.966.8557.

Fracture Wall Panels | March 2026

Colorways

PREMIER

							
White WH12	Milkyway MI74	Ivory IV11	Pearl PE21	Valentine VA70	Quartz QU67	Stonewash ST72	Sea Salt SE57
							
Platinum PL04	Almond AL55	Pistachio PI25	Turmeric TU60	Flamingo FL61	Amethyst AM69	Periwinkle PE23	Peacock PE20
							
Metal ME03	Mushroom MU75	Celery CE65	Wheat WH68	Peach PE19	Lilac LI13	Marine MA15	Sencha SE58
							
Grey GR02	Umber UM54	Wasabi WA29	Popcorn PO26	Currant CU59	Berry BE06	Azure AZ05	Oregano OR18
							
Charcoal CH01	Walnut WA56	Eucalyptus EU71	Carrot CA08	Loganberry LO77	Granite GR62	Denim DE09	Kale KA12
							
Piano Black PI24	Slate SL27	Nori NO76	Peppercorn PE22	Shiraz SH63	Flint FL64	Midnight MI16	

Order samples at acoufelt.com/colorways

 For questions or additional product information, visit acoufelt.com or call 800.966.8557.

Fracture Wall Panels | March 2026

Sizes

Standard Sizes 48" W x 108" H
*Custom sizes available**

Plan

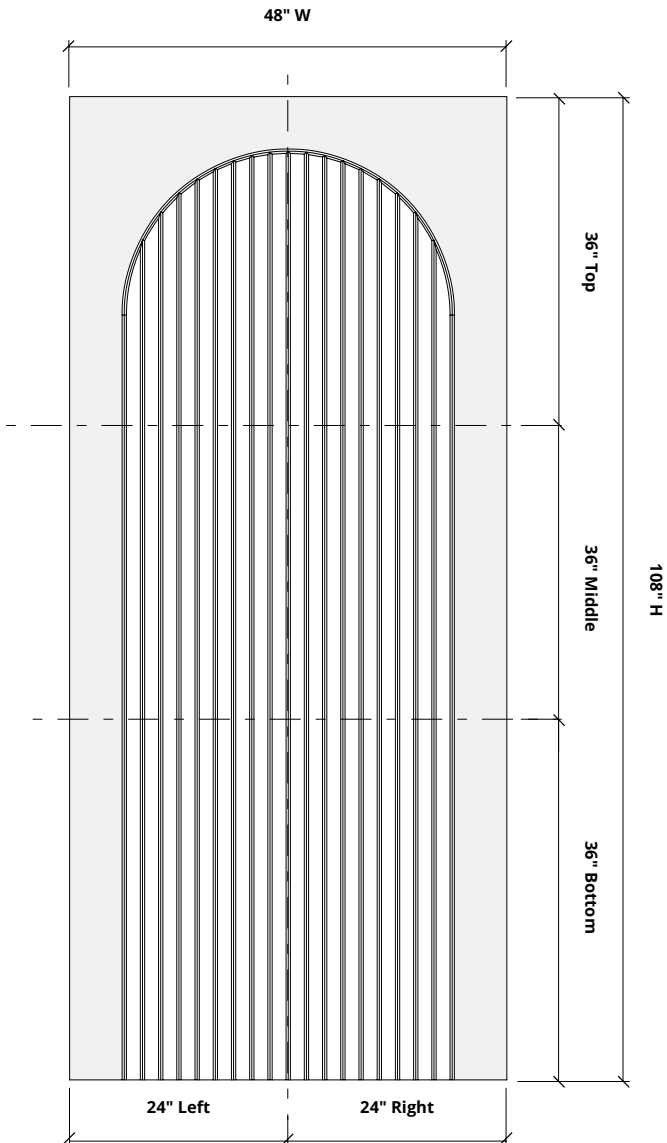

Perspective

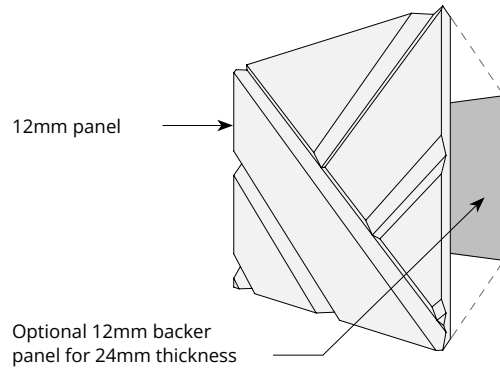

* Most designs available as full panels or as sections of a panel as filler pieces. Choose any of the standard height or segments (i.e. bottom right, middle left, etc) to fill the space as needed.

** Blossoms only available in thirds (top, middle and bottom - 36" H x 48" W); or vertical halves (left and right - 24" W x 108" H)

*** Harmony is only available in full-size panels.

How to Specify

1. Choose Panel Design

2. Determine Sizing

3. Choose Colorways

Select desired panel design. See recommended layouts for larger designs.

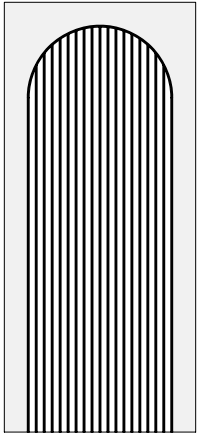

ARCH



BLOSSOMS
(2-PANEL DESIGN)

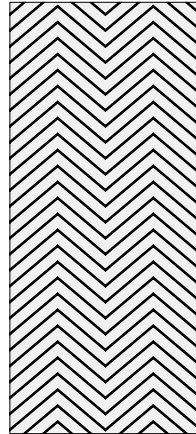
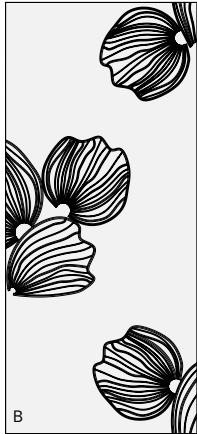

CHEVRON

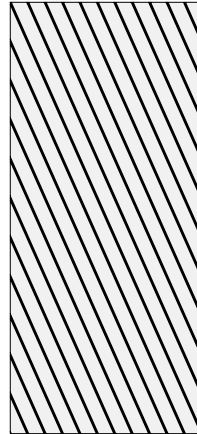

DIAGONAL

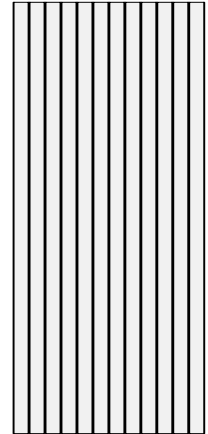

FINELINE

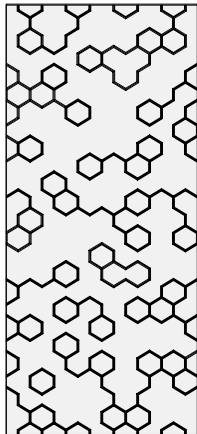

FORMULA

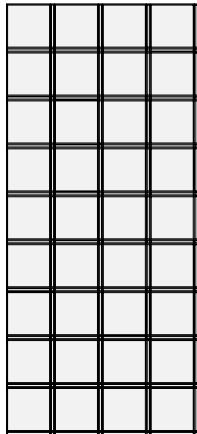

GALLERY

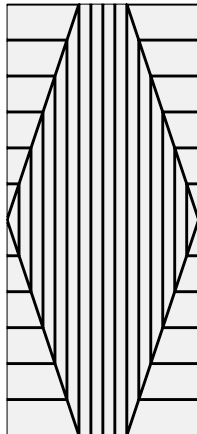

HARLEQUIN

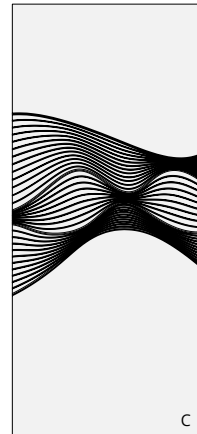
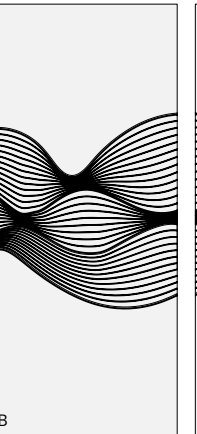
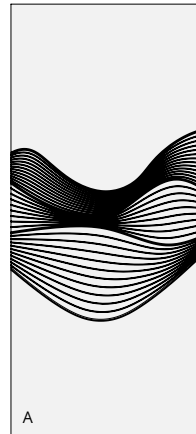

HARMONY
(3-PANEL DESIGN)



For questions or additional product information,
visit [acoufelt.com](https://www.acoufelt.com) or call 800.966.8557.

Fracture Wall Panels | March 2026

How to Specify (cont.)

1. Choose Panel Design

2. Determine Sizing

3. Choose Colorways

Select desired panel design. See recommended layouts for larger designs.

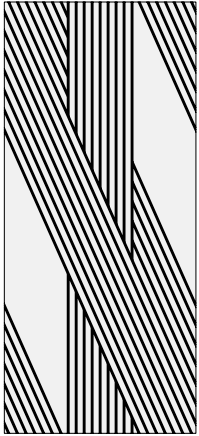

INTERSECT

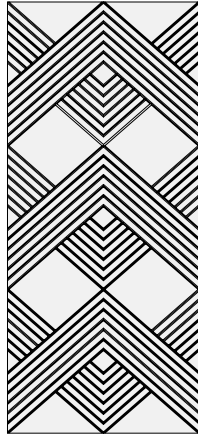

KNIT

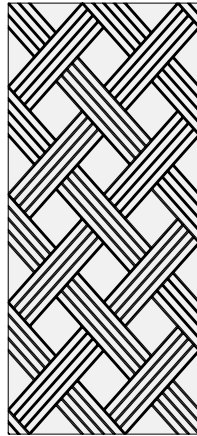

LATTICE

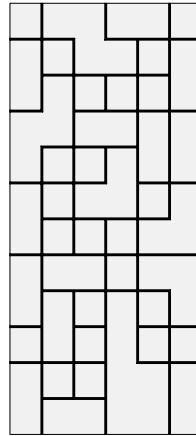

MAZE

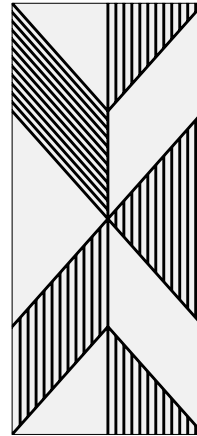

METROPOLIS

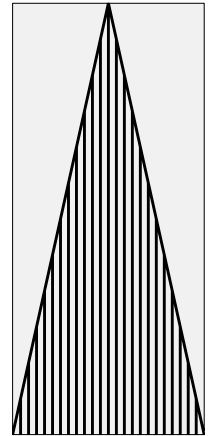

PENNANT

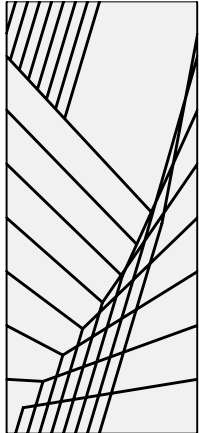

PRISM

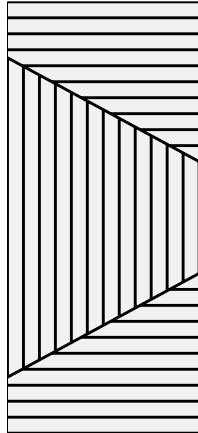

PULSE

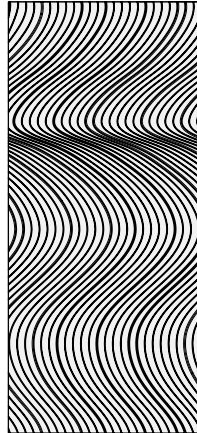

RHYTHM

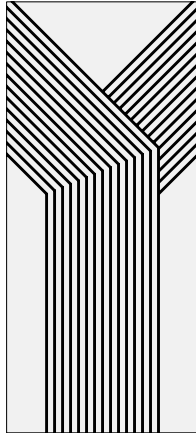

ROWHOUSE

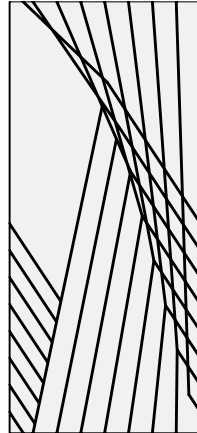

SPIROGRAPH

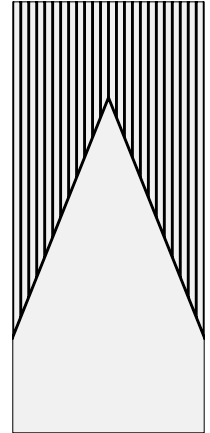

SUMMIT



For questions or additional product information, visit [acoufelt.com](https://www.acoufelt.com) or call 800.966.8557.

Fracture Wall Panels | March 2026

How to Specify (cont.)

1. Choose Panel Design

2. Determine Sizing

3. Choose Colorways

Select desired panel design. See recommended layouts for larger designs.

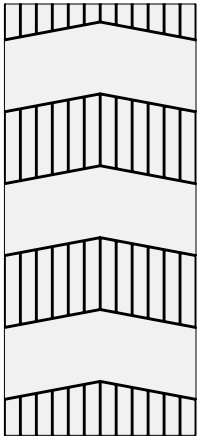

TRACK

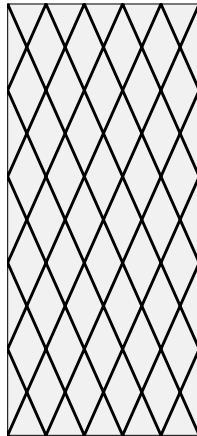

TRELLIS

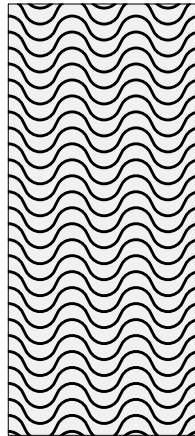

WAVELENGTH

1. Choose Panel Design

2. Determine Sizing

3. Choose Colorways

Calculate how many panels you need and if you need additional sections.

- Most designs available as full panels or as sections of a panel as filler pieces. Choose any of the standard height or segments (i.e. bottom right, middle left, etc) to fill the space as needed.
- Blossoms only available in horizontal thirds (top, middle and bottom - 36" H x 48" W); or vertical halves (left and right - 24" W x 108" H)
- Harmony is only available in full-size panels—no sections.

1. Choose Panel Design

2. Determine Sizing

3. Choose Colorways

See colorways on page 3.

Recommended Layouts

Arch

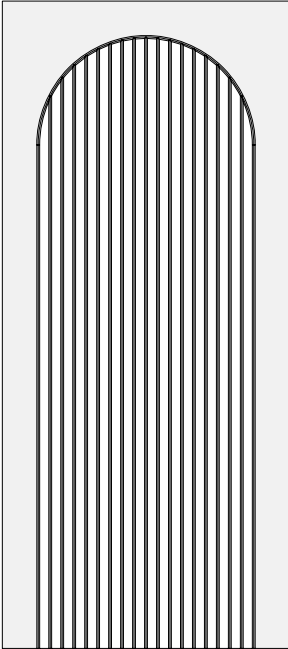

Fracture, Arch Wall Panels in Currant

Layout 1

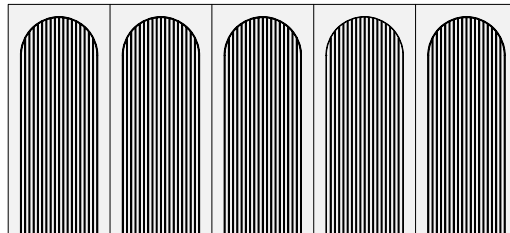

Layout 2

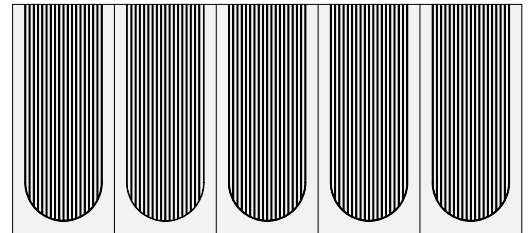

Layout 3

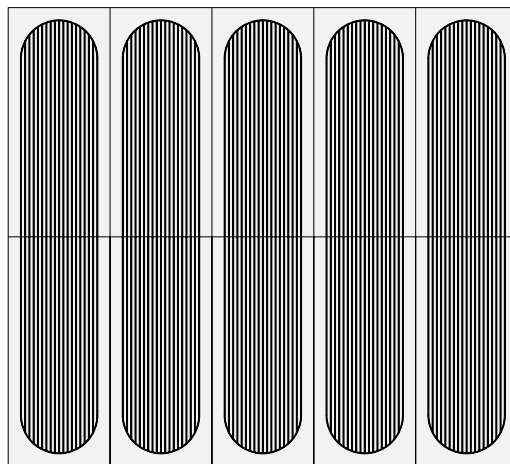

Layout 4

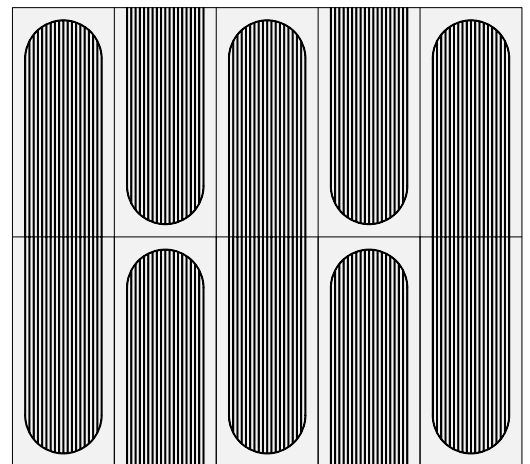

Recommended Layouts

Blossoms

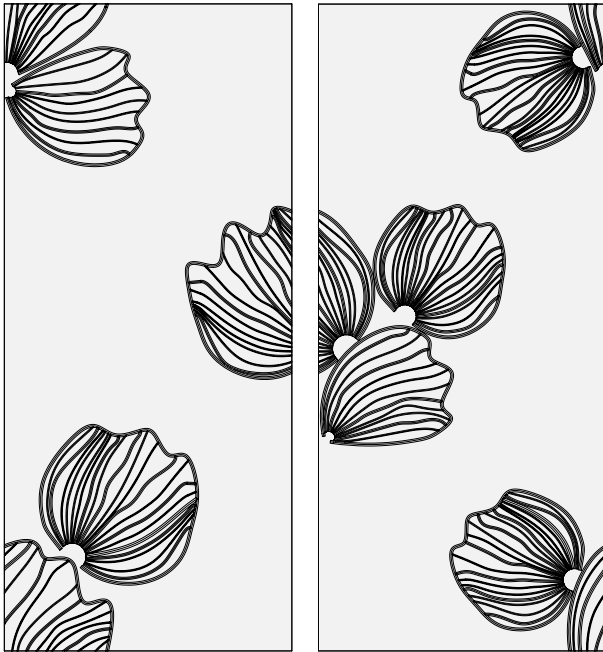

Panel A

Panel B

Layout 1

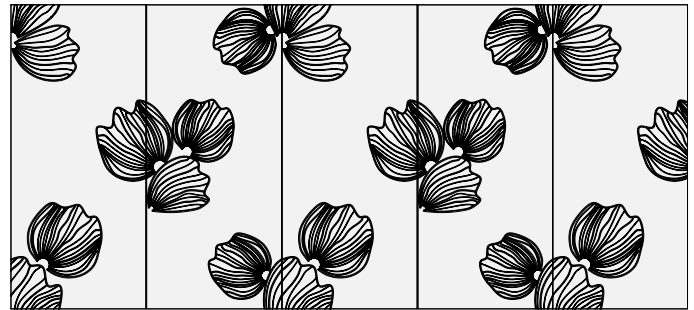

A B A B A

** Blossoms only available in horizontal thirds (top, middle and bottom - 36" H x 48" W); or vertical halves (left and right - 24" W x 108" H)*



Fracture, Blossoms Wall Panels in Loganberry

 For questions or additional product information, visit [acoufelt.com](https://www.acoufelt.com) or call 800.966.8557.

Fracture Wall Panels | March 2026

Recommended Layouts

Chevron

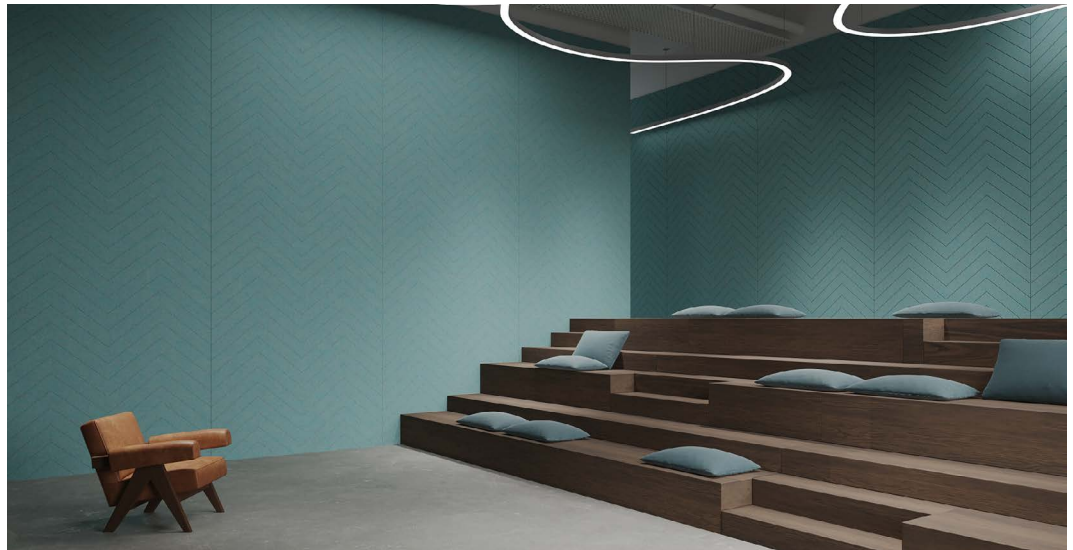

Fracture, Chevron Wall Panels in Sea Salt

Layout 1

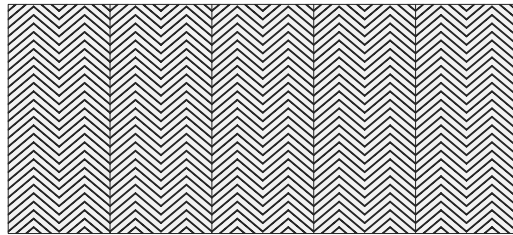

Layout 2

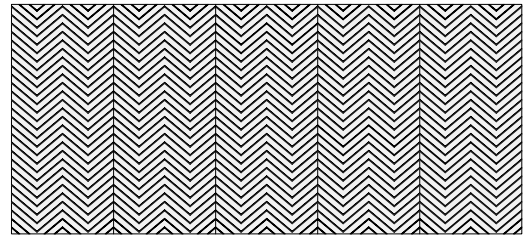

Layout 3

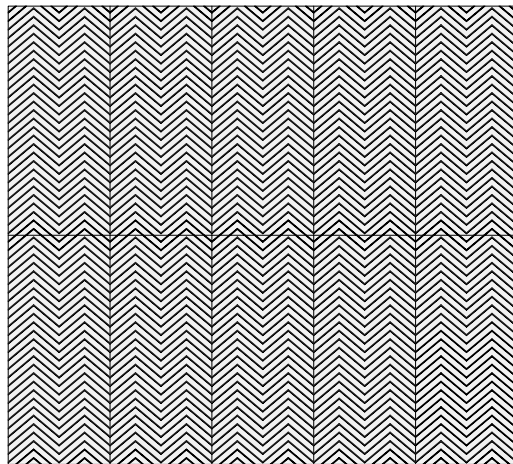

Layout 4

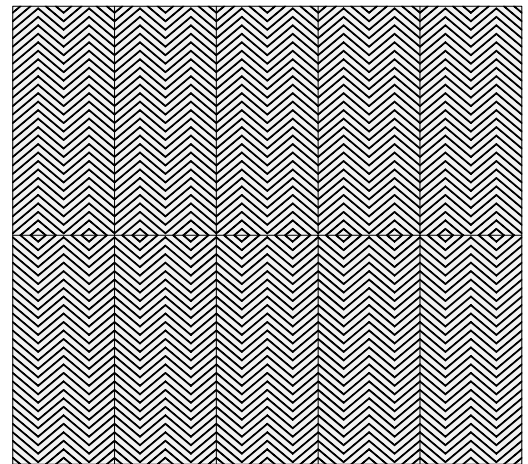

Recommended Layouts

Diagonal

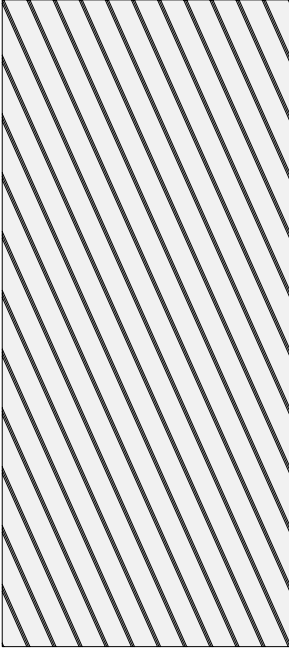

Fracture, Diagonal Wall Panels in Pistachio

Layout 1

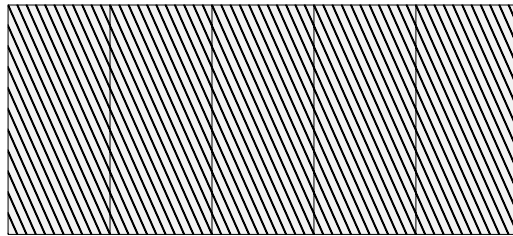

Layout 2

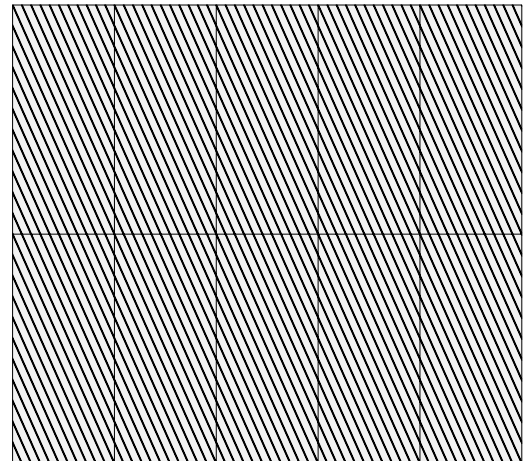

Recommended Layouts

Fineline

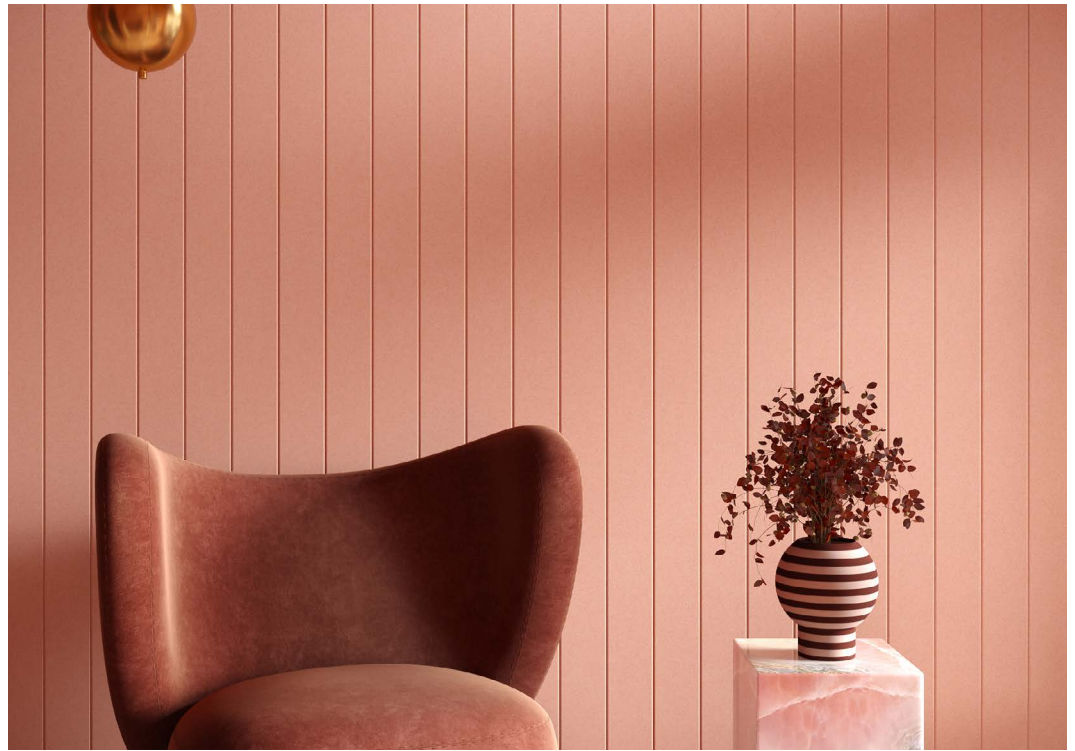
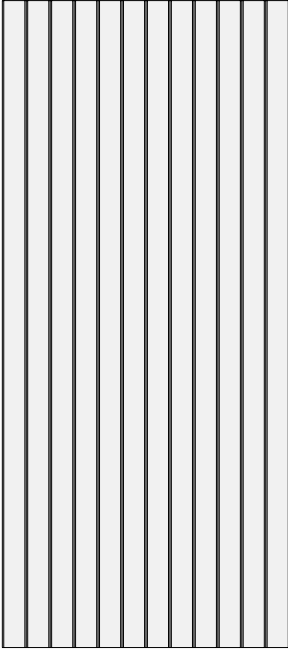

Fracture, Fineline Wall Panels in Flamingo

Layout 1

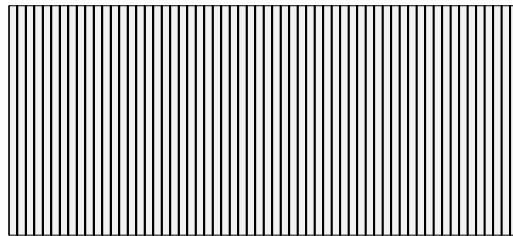

Layout 2

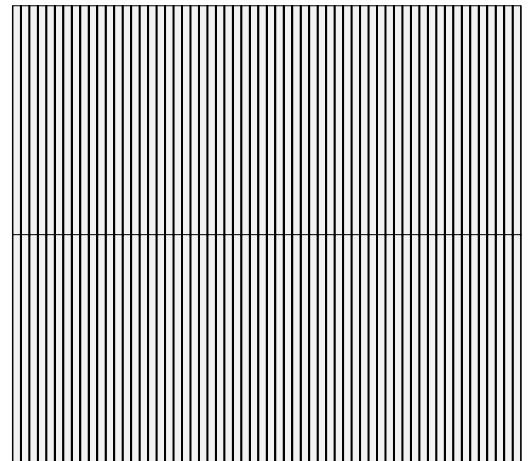

Recommended Layouts

Formula

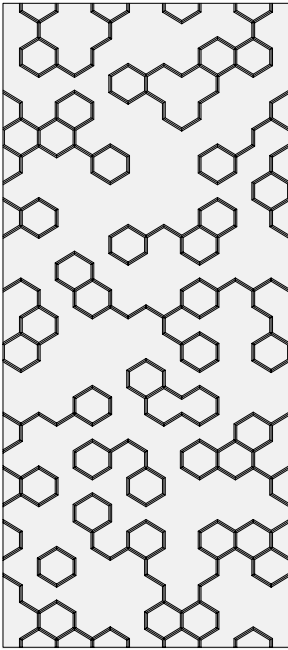

Fracture, Formula Wall Panels in Pearl

Layout 1

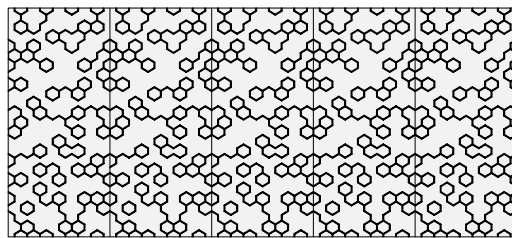

Layout 2

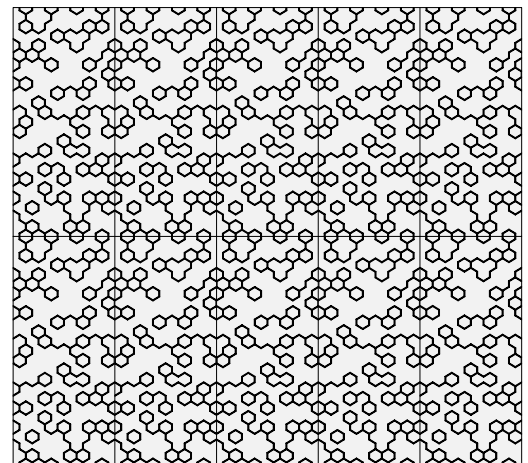

Recommended Layouts

Gallery

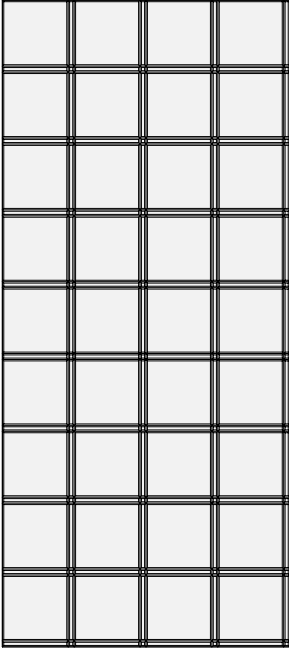

Fracture, Gallery Wall Panels in Nori

Layout 1

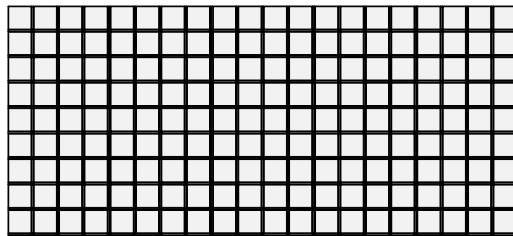

Layout 2

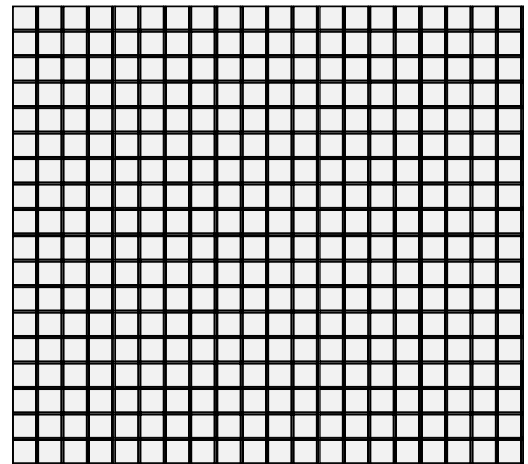

Recommended Layouts

Harlequin

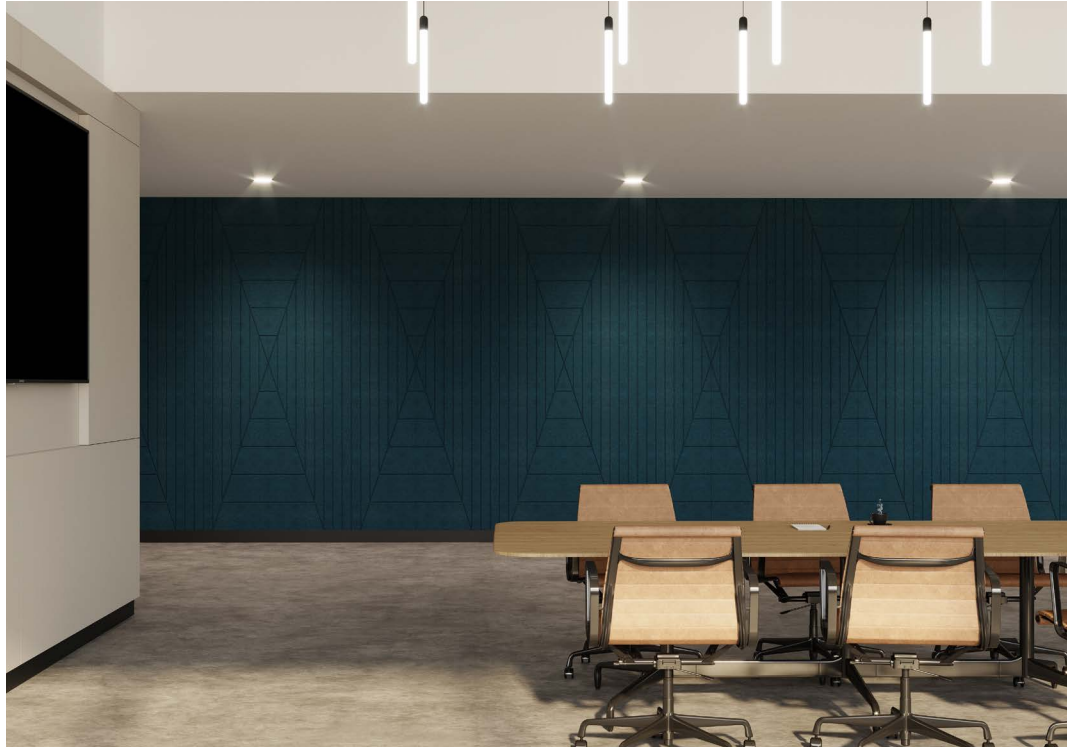
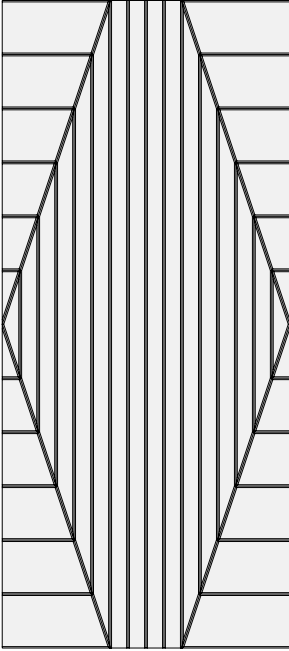

Fracture, Harlequin Wall Panels in Denim

Layout 1

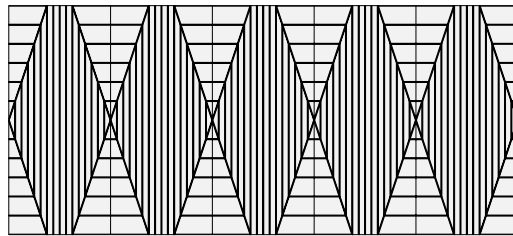

Layout 2

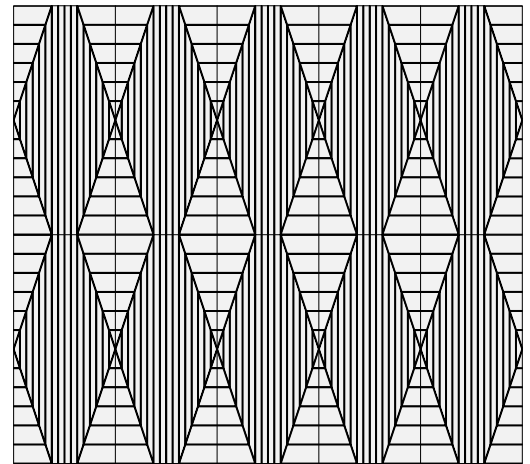

Recommended Layouts

Harmony

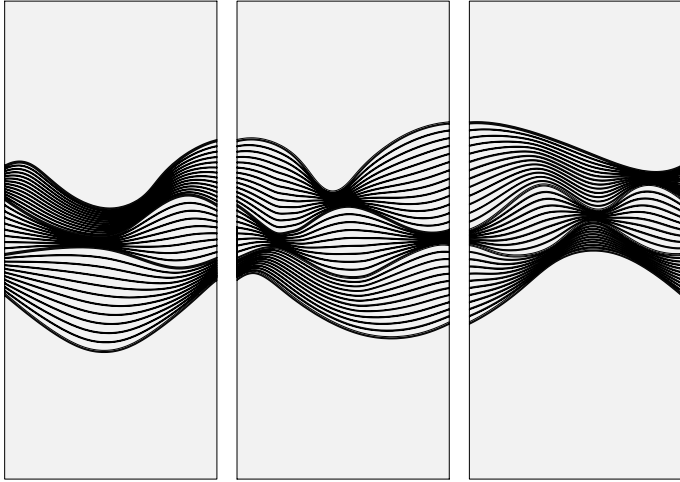

Panel A

Panel B

Panel C



Fracture, Harmony Wall Panels in Loganberry (Layout 2 shown)

* Harmony is only available in full panel sizes.

Layout 1

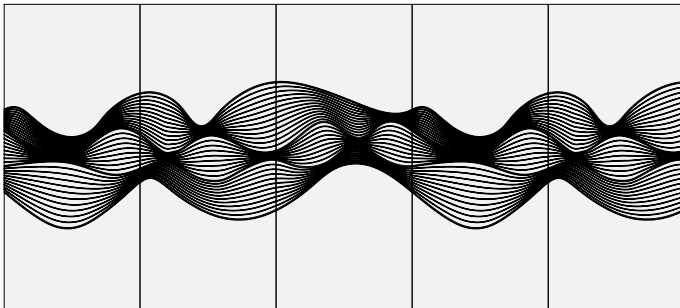

A

B

C

A

B

Layout 2 (Panels rotated 180°)

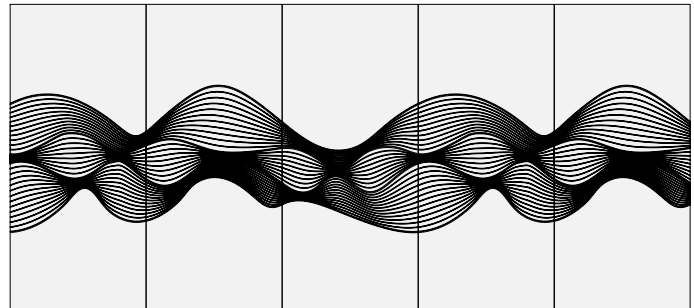

B

A

C

B

A



For questions or additional product information, visit [acoufelt.com](https://www.acoufelt.com) or call 800.966.8557.

Fracture Wall Panels | March 2026

Recommended Layouts

Intersect

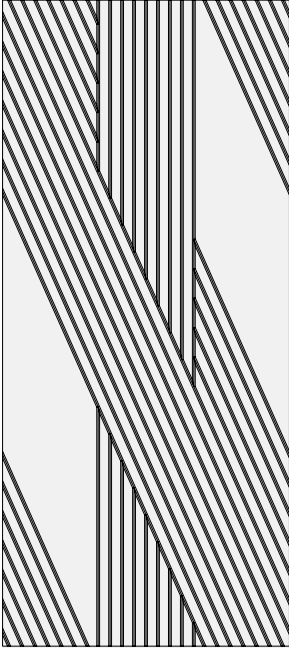

Fracture, Intersect Wall Panels in Kale

Layout 1

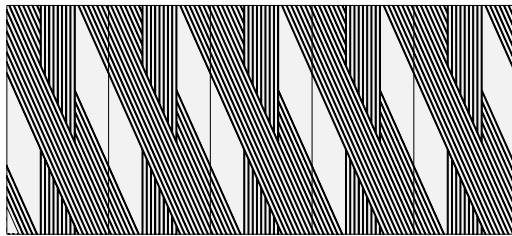

Layout 2

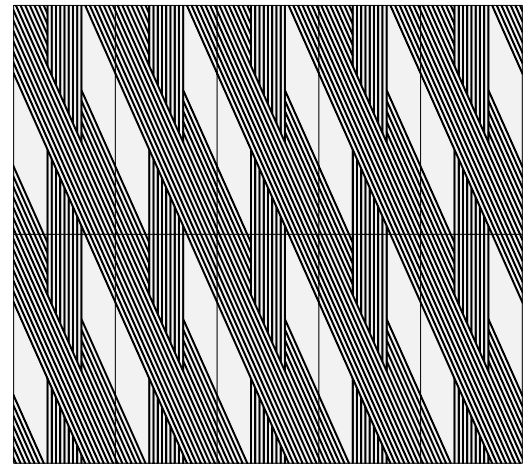

Recommended Layouts

Knit

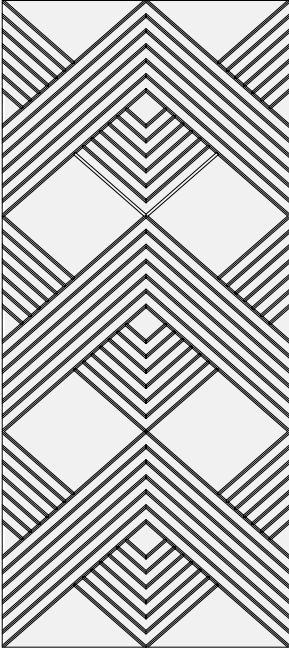

Fracture, Knit Wall Panels in Pistachio

Layout 1

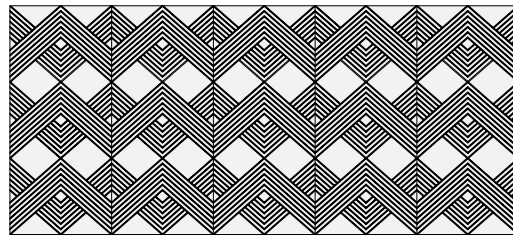

Layout 2

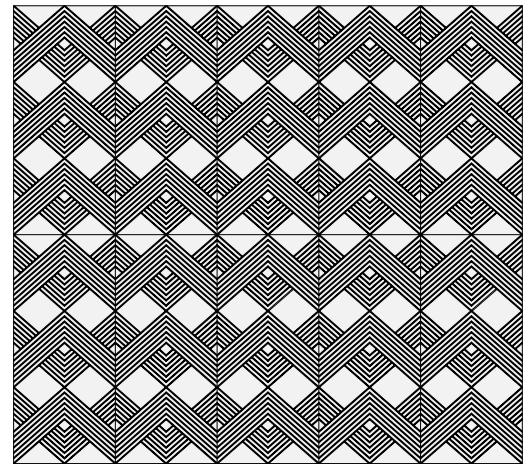

Recommended Layouts

Lattice

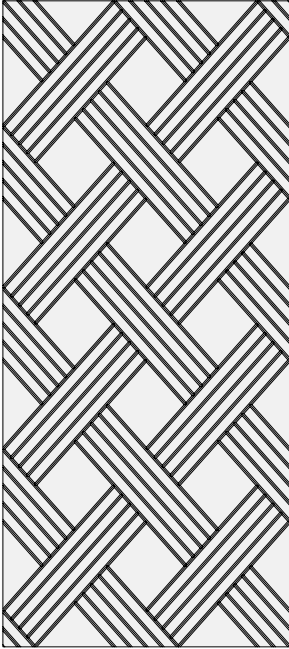

Fracture, Lattice Wall Panels in Sencha

Layout 1

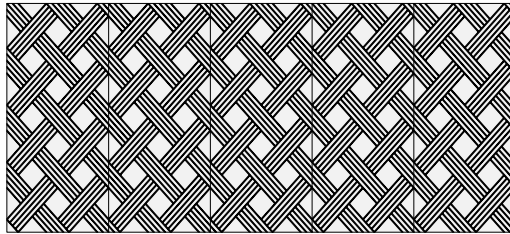

Layout 2

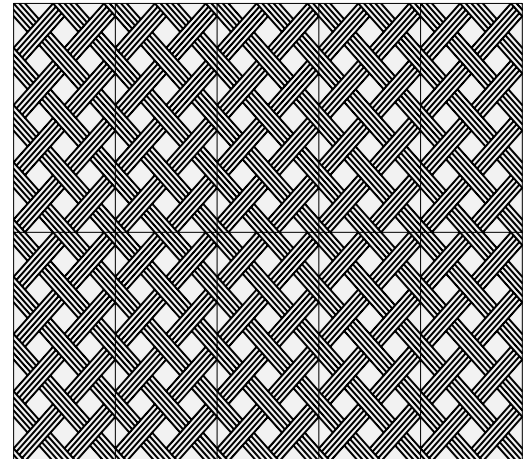

Recommended Layouts

Maze

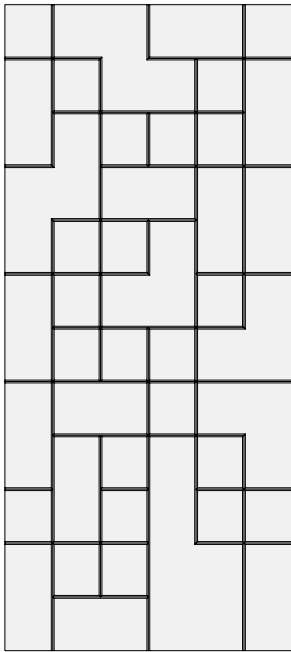

Fracture, Maze Wall Panels in Metal

Layout 1

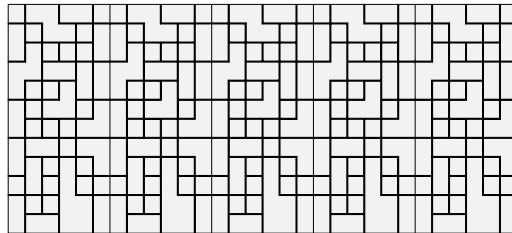

Layout 2

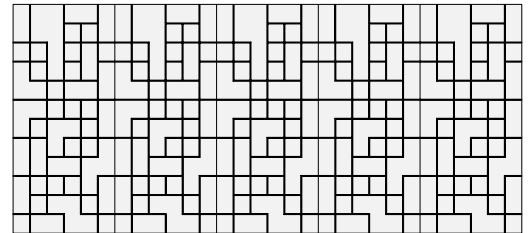

Layout 3

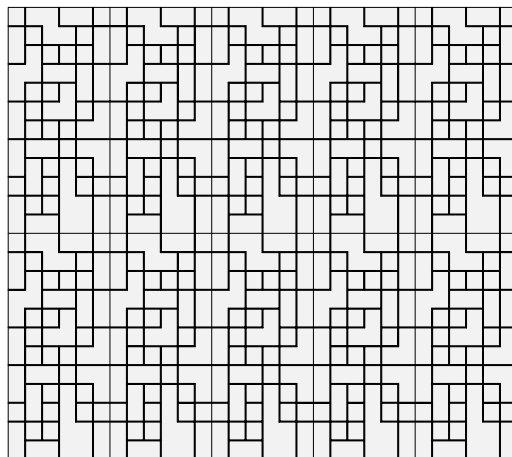

Layout 4

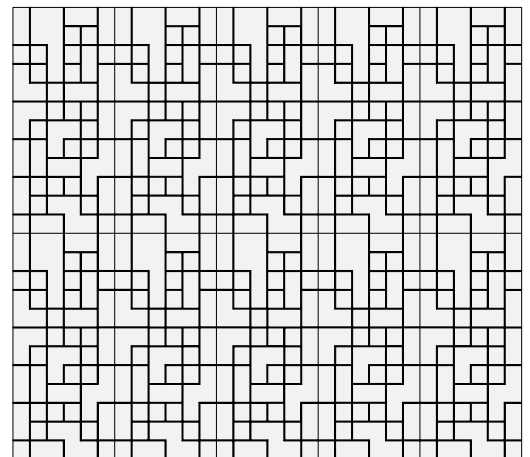

Recommended Layouts

Metropolis

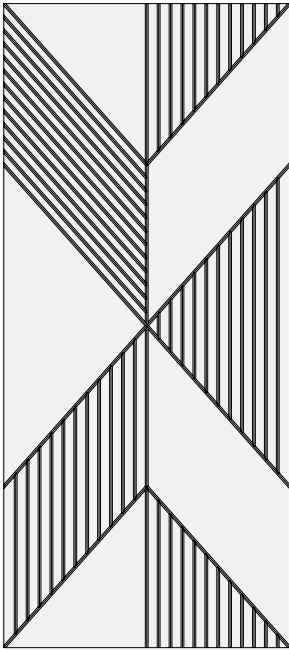

Fracture, Metropolis Wall Panels in Metal

Layout 1

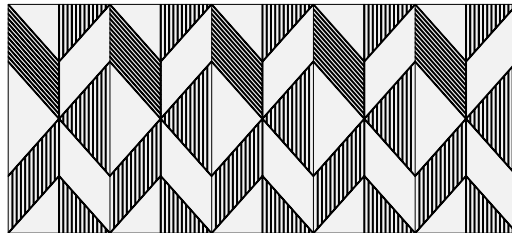

Layout 2

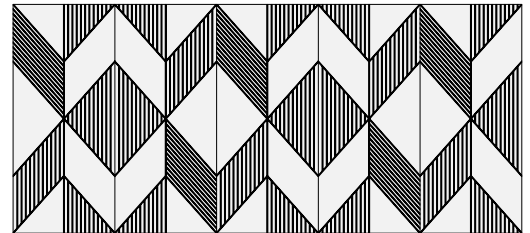

Layout 3

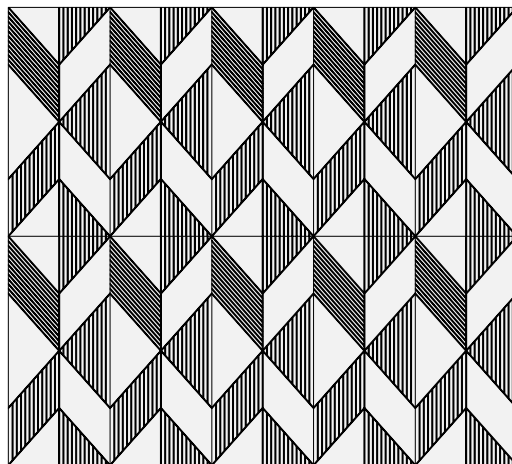

Layout 4

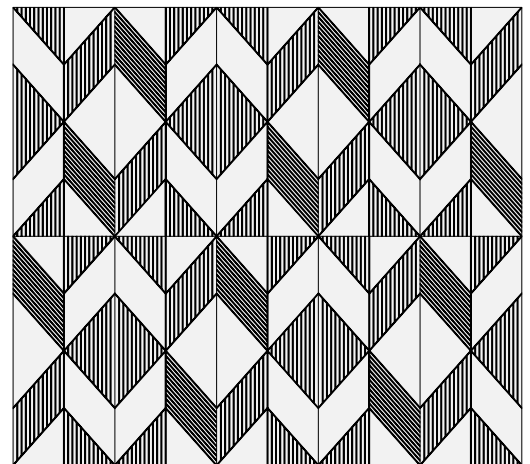

Recommended Layouts

Pennant

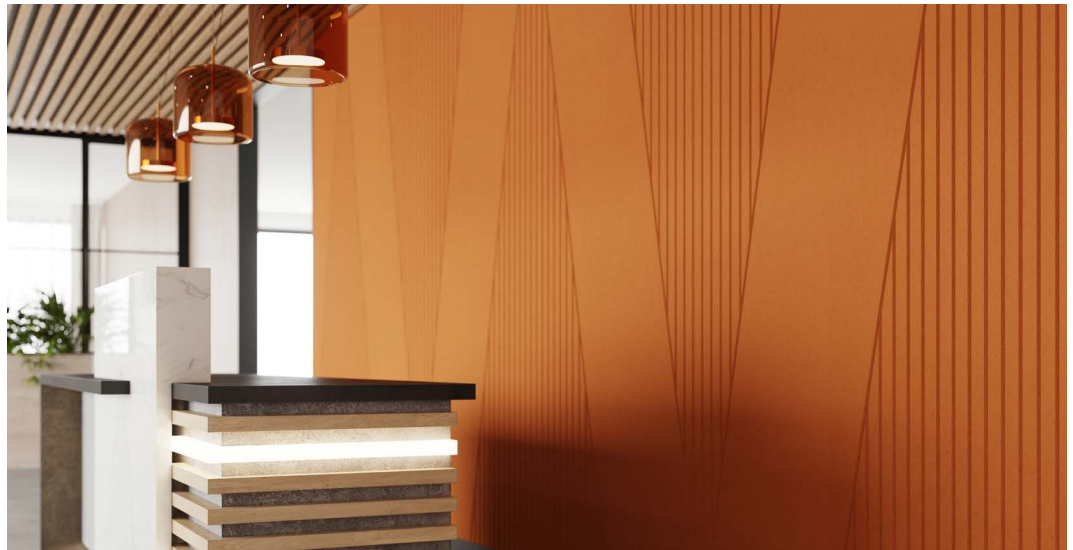
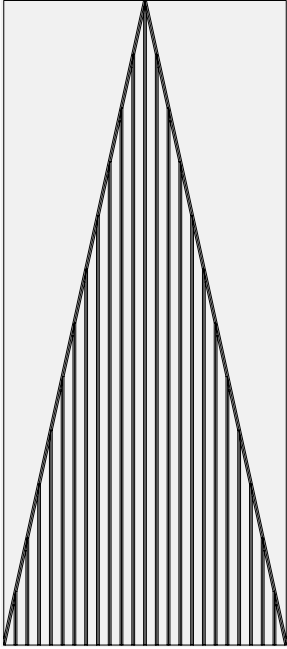

Fracture, Pennant Wall Panels in Peach

Layout 1

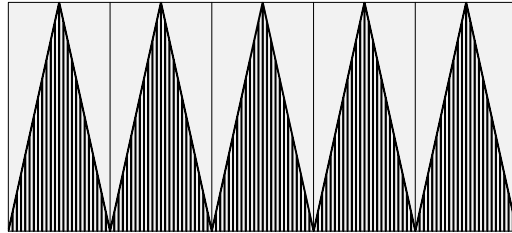

Layout 2

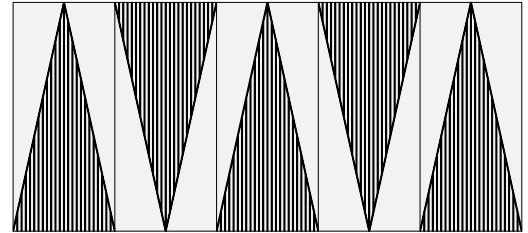

Layout 3

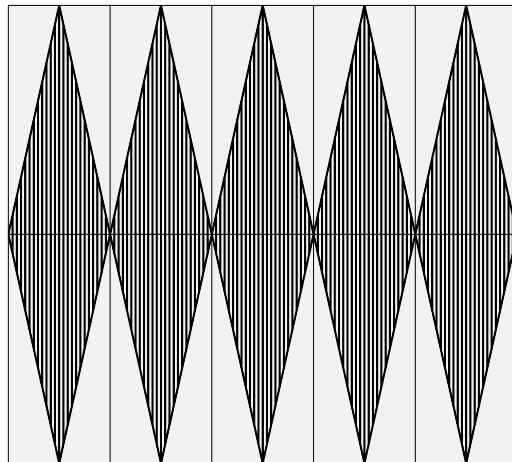

Layout 4

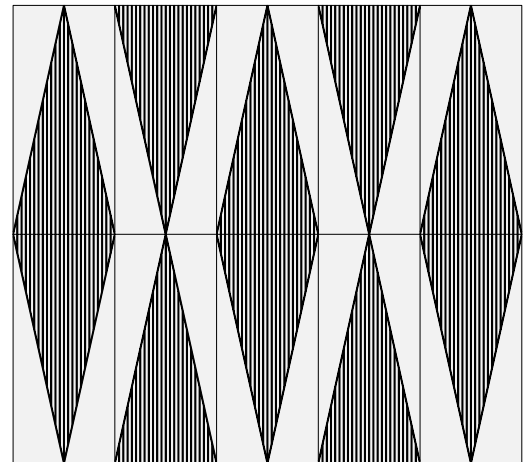

Recommended Layouts

Prism

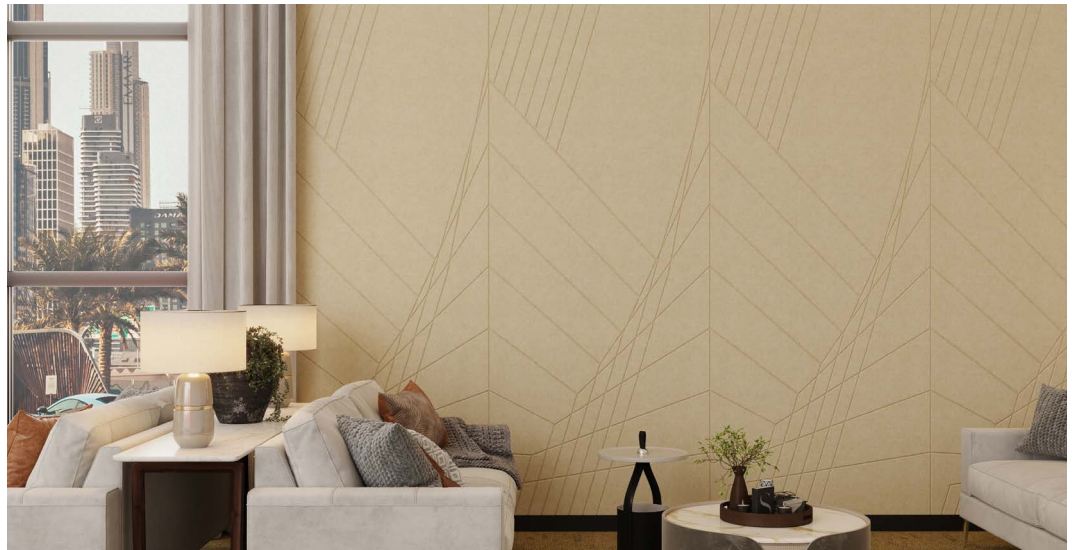
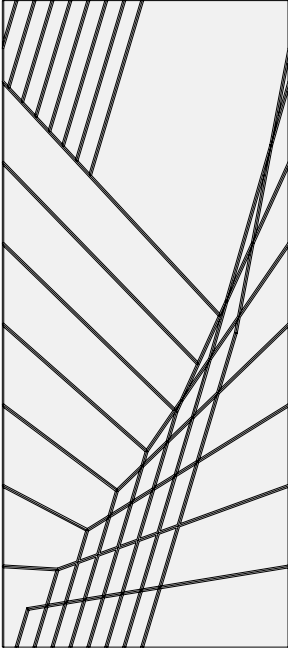

Fracture, Prism Wall Panels in Ivory

Layout 1

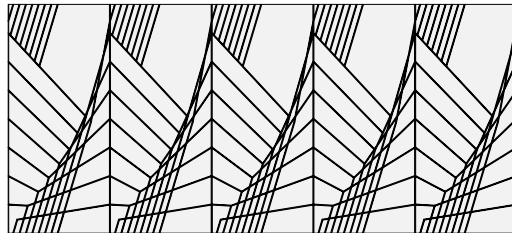

Layout 2

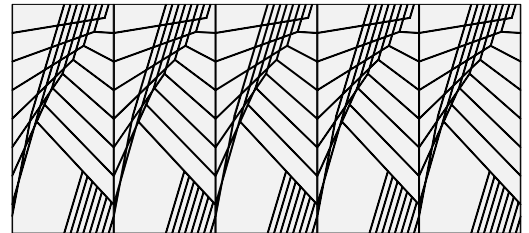

Layout 3

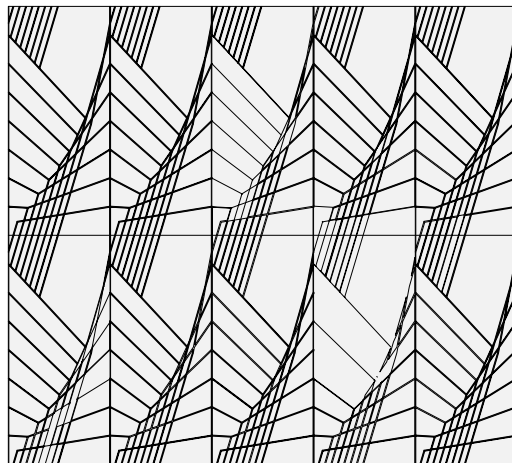

Layout 4

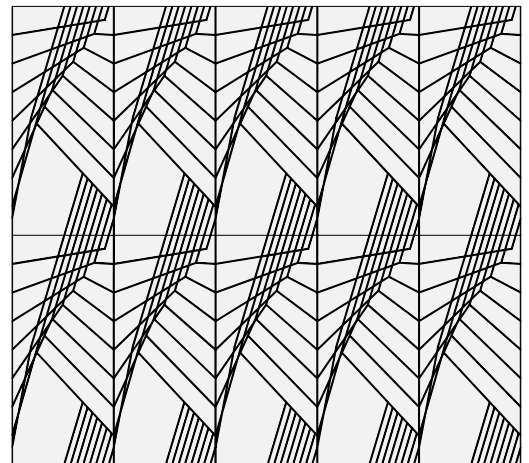

Recommended Layouts

Pulse

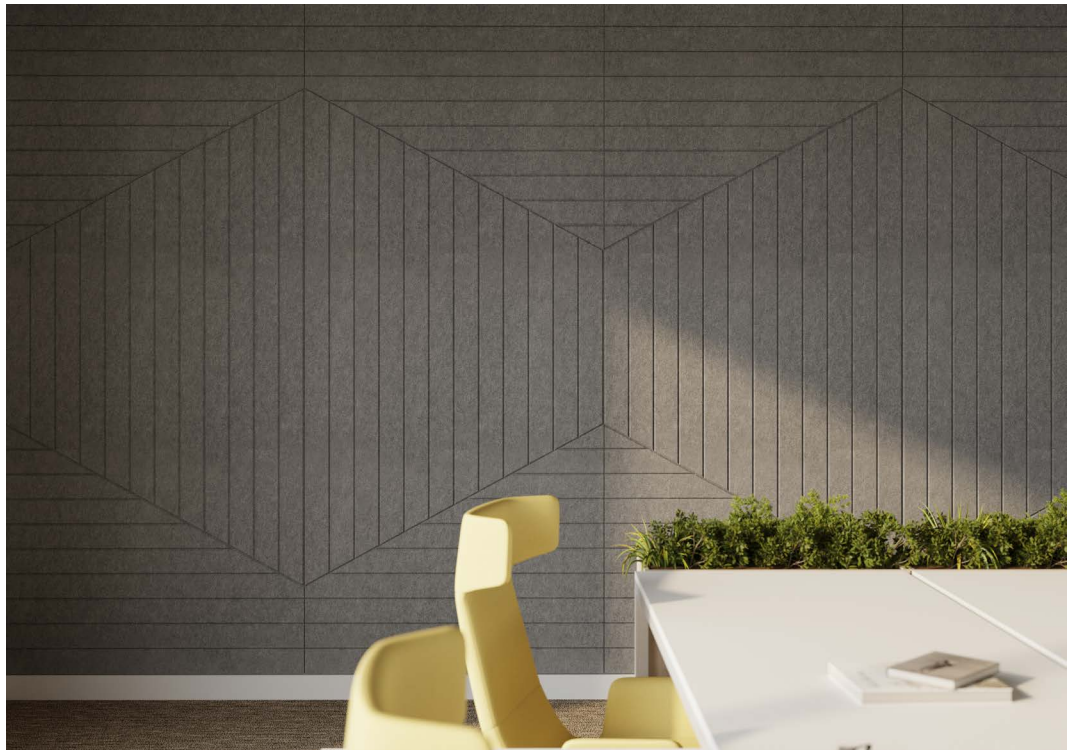
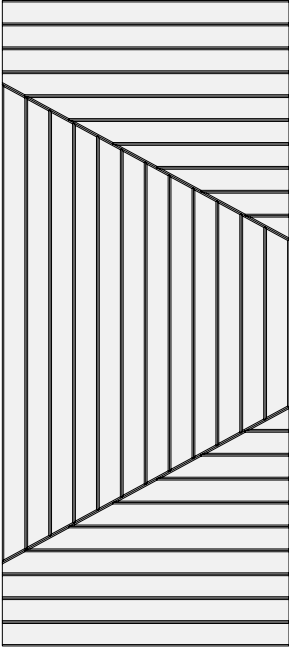

Fracture, Pulse Wall Panels in Slate

Layout 1

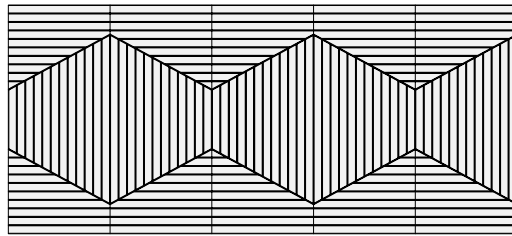

Layout 2

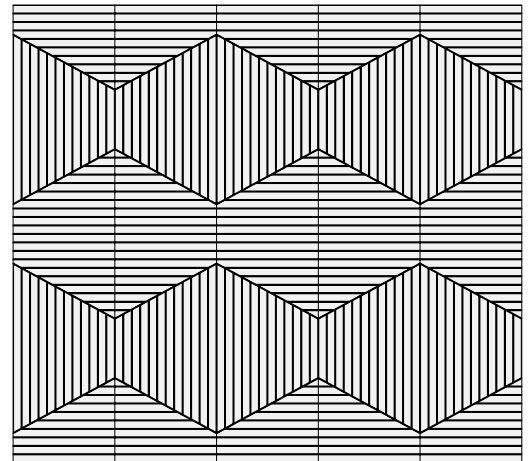

Recommended Layouts

Rhythm

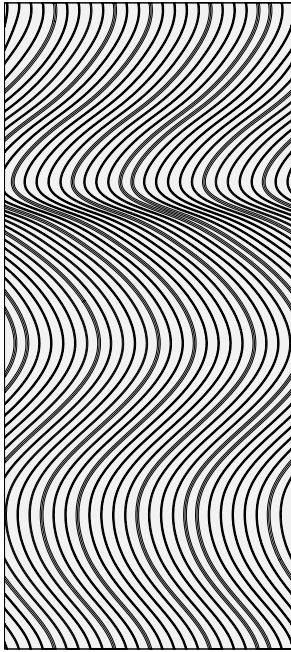

Fracture, Rhythm Wall Panels in Sencha

Layout 1

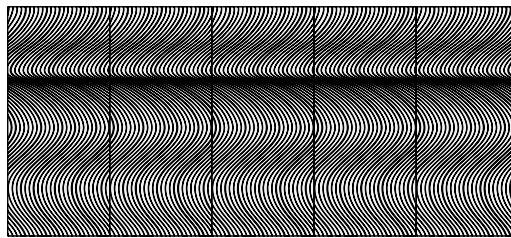

Layout 2

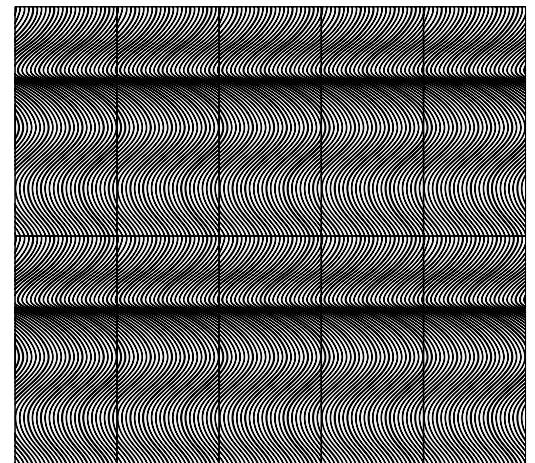

Recommended Layouts

Rowhouse

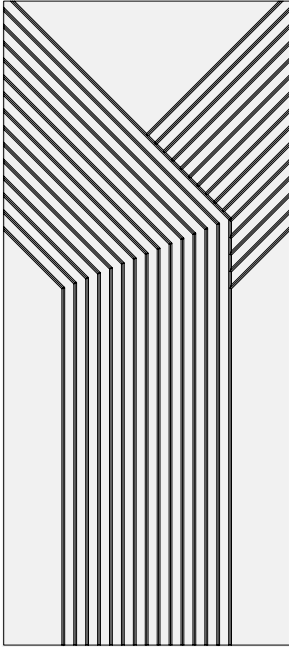

Fracture, Rowhouse Wall Panels in Pearl

Layout 1

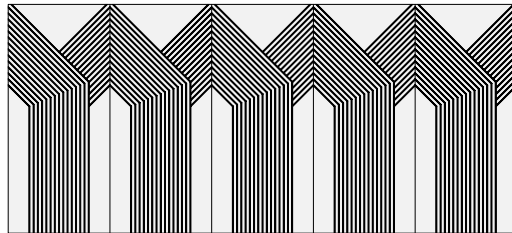

Layout 2

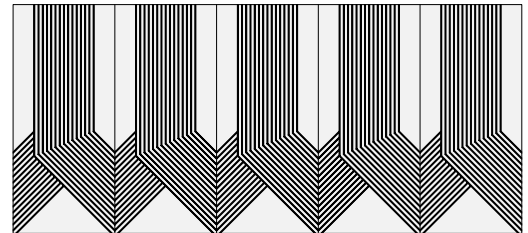

Layout 3

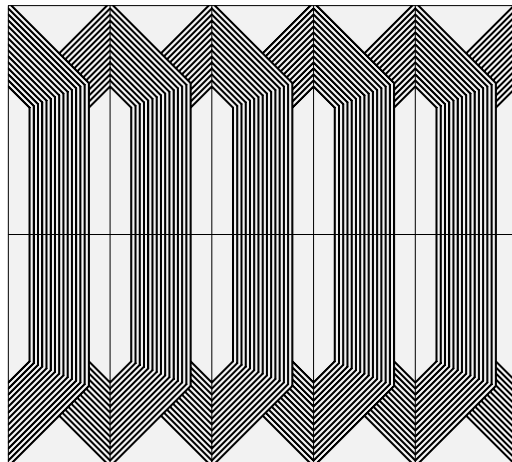

Layout 4

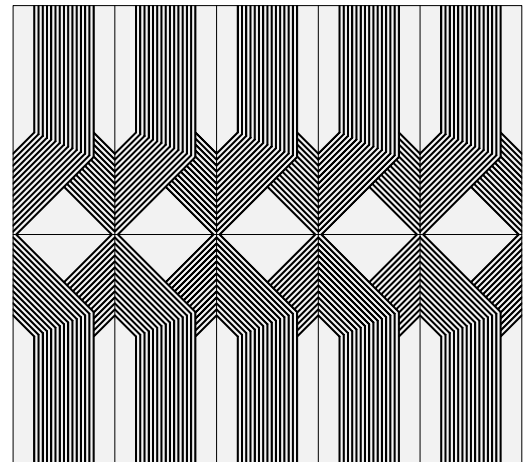

Recommended Layouts

Spirograph

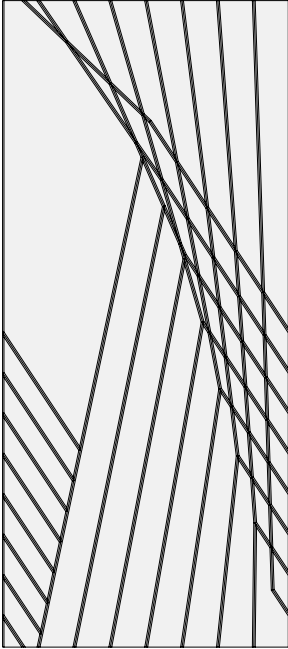

Fracture, Spirograph Wall Panels in Platinum

Layout 1

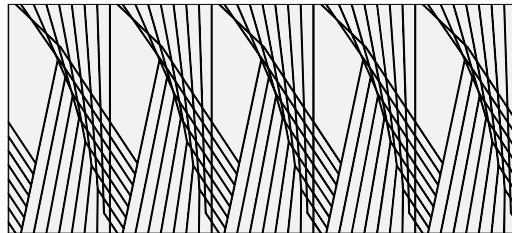

Layout 2

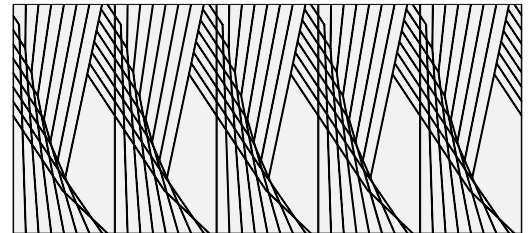

Layout 3

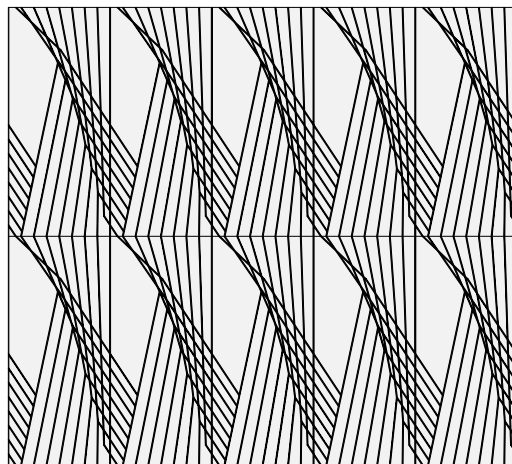

Layout 4

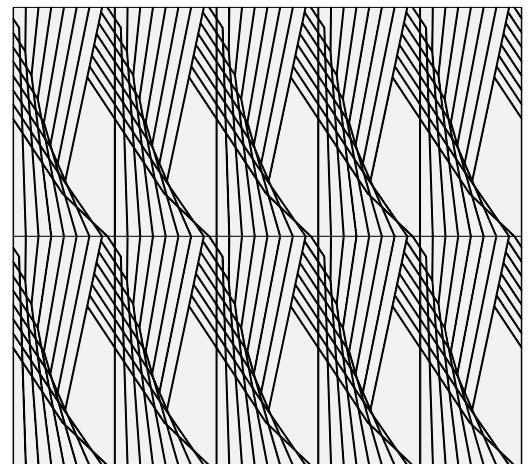

Recommended Layouts

Summit

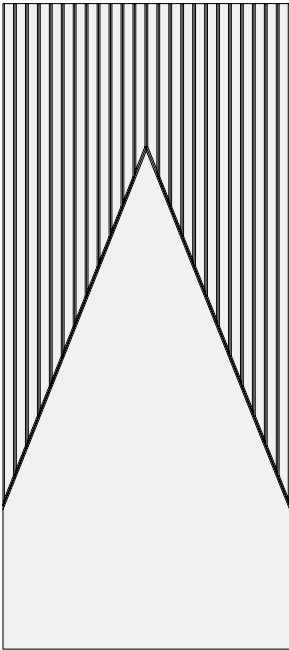

Fracture, Summit Wall Panels in Periwinkle

Layout 1

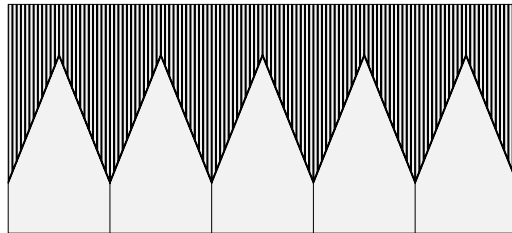

Layout 2

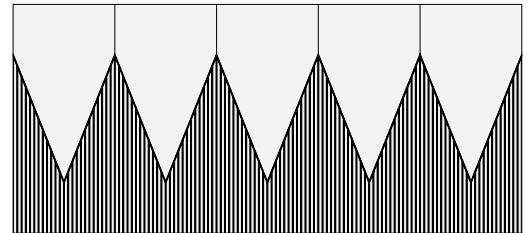

Layout 3

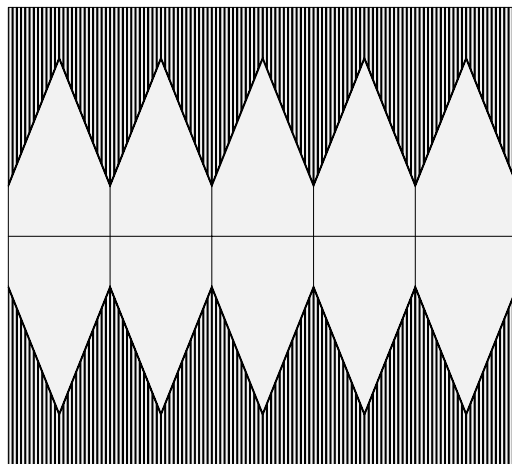

Layout 4

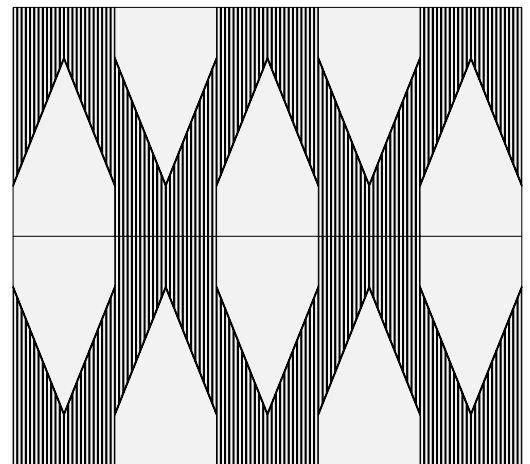

Recommended Layouts

Track

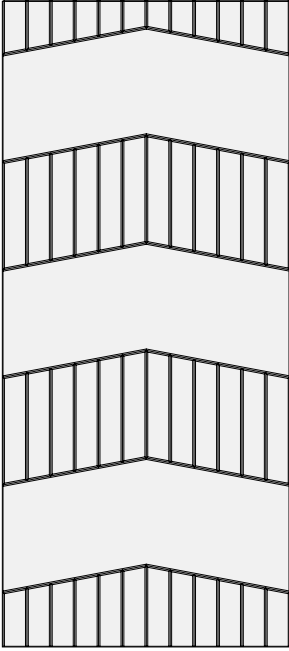

Fracture, Track Wall Panels in Denim

Layout 1

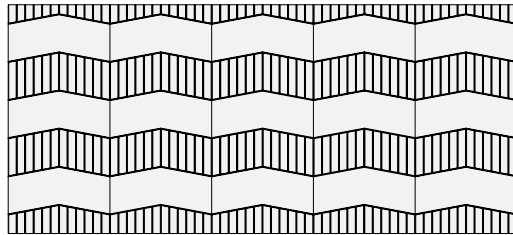

Layout 2

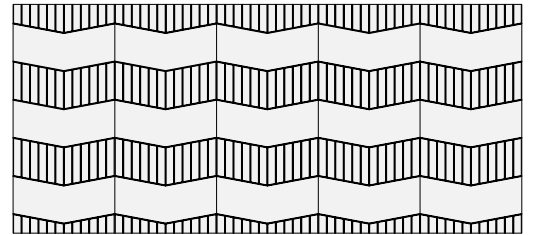

Layout 3

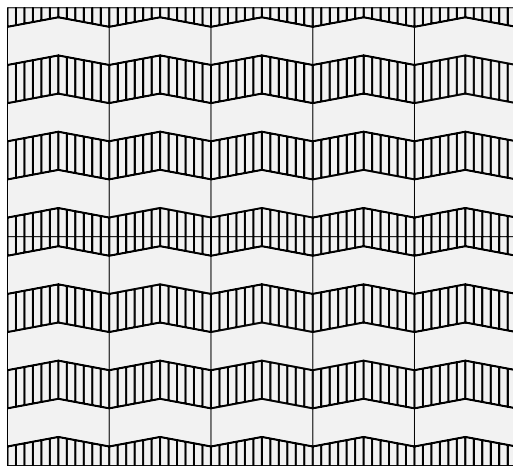

Layout 4

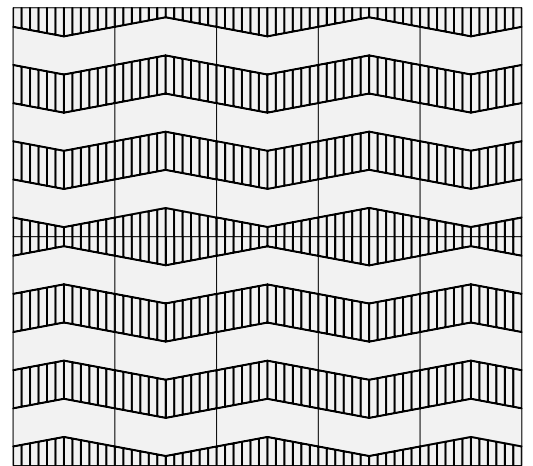

Recommended Layouts

Trellis

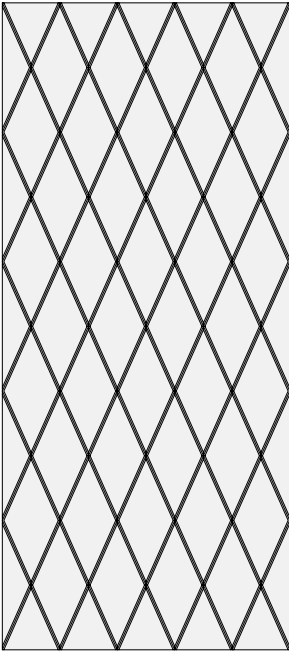

Fracture, Trellis Wall Panels in Charcoal

Layout 1

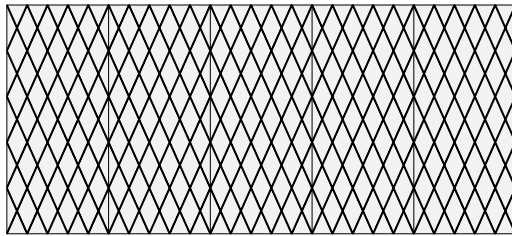

Layout 2

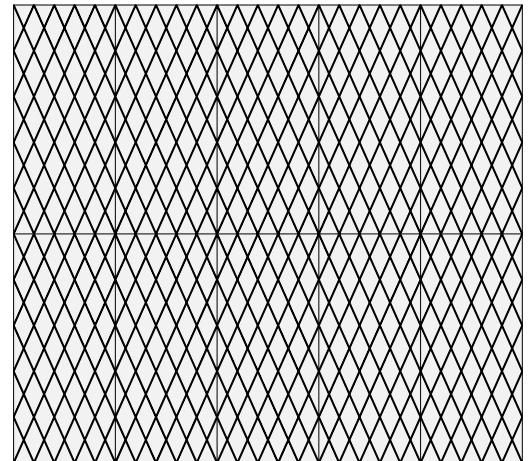

Recommended Layouts

Wavelength

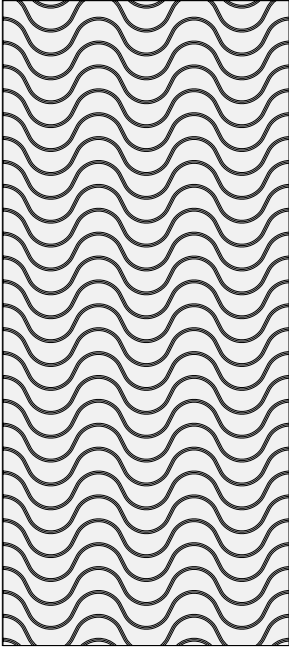

Fracture, Wavelength Wall Panels in Wasabi

Layout 1

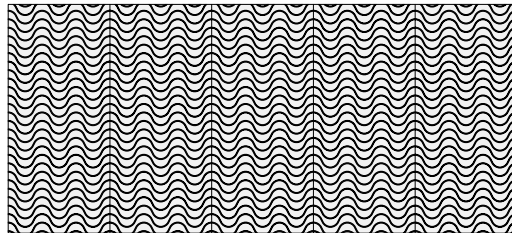

Layout 2

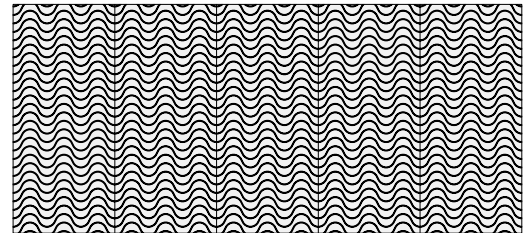

Layout 3

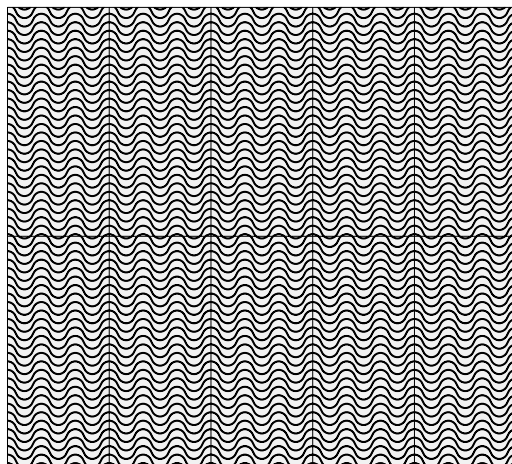

Layout 4

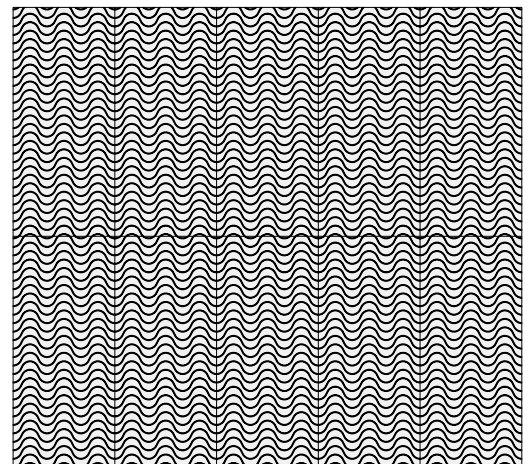

Mounting Methods

Adhesive backing

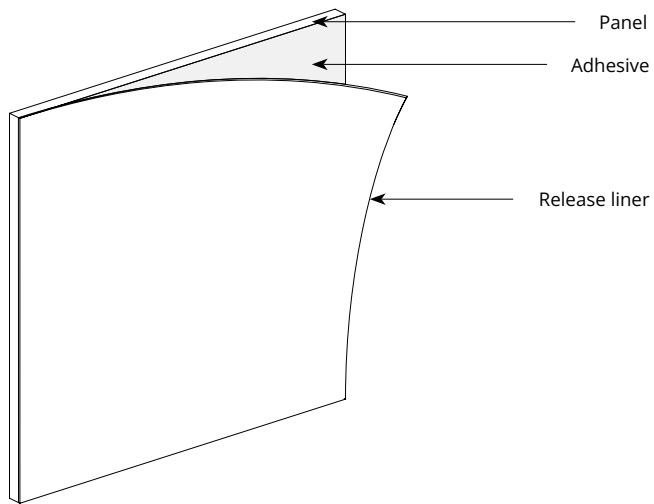

Construction adhesive

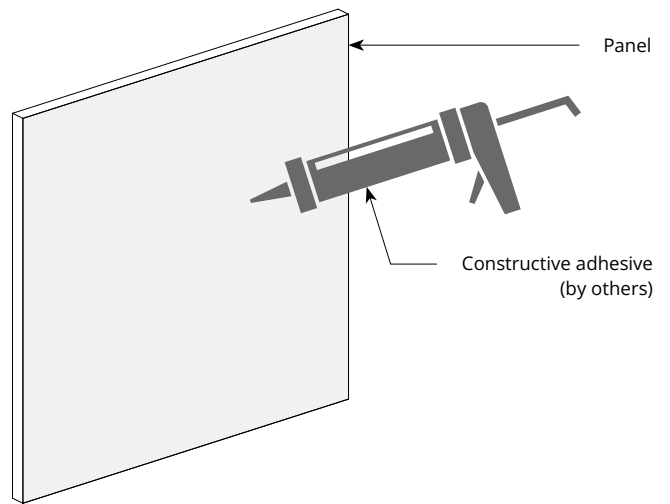

Z-clip wall mount

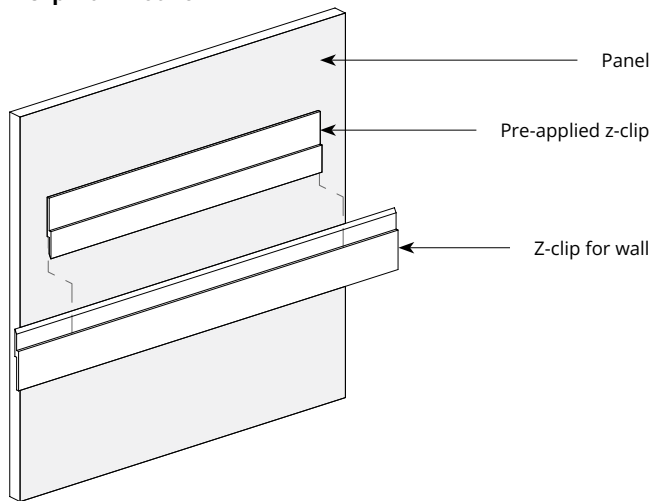

** For wall mount applications only.*

Acoustic Performance

Test Method	ASTM C423-09a
Install Method	A
Rating Method	ISO 11654-1997
Test Results	<p>12mm NRC 0.45, no air gap NRC 0.54, 12mm air gap NRC 0.64, 20mm air gap SAA 0.43, no air gap SAA 0.54, 12mm air gap</p> <p>24mm NRC 0.60, no air gap SAA 0.55, no air gap</p>

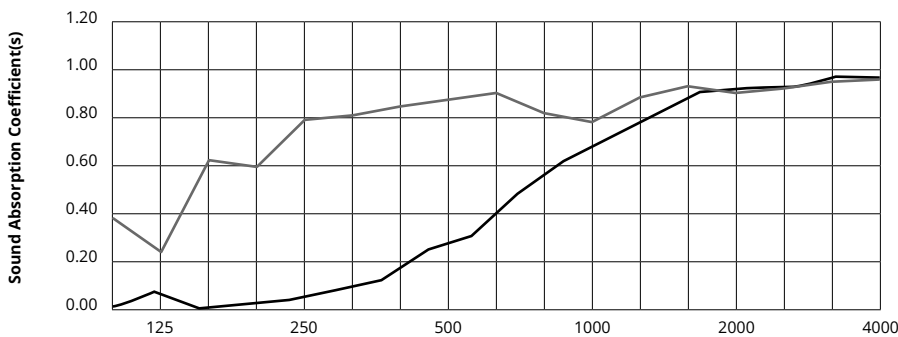

	Frequency f (Hz)	125	250	500	1000	2000	4000	NRC
	12mm	0.06	0.02	0.23	0.61	0.89	0.95	0.45
	24mm	0.02	0.57	0.41	0.58	0.87	0.85	0.60

What is a Noise Reduction Coefficient (NRC)?

You'll find the NRC rating in the specifications of all of our products. This acronym stands for Noise Reduction Coefficient, and is expressed as a single number, a rating that describes the degree to which acoustic products can absorb sound.

You can use NRC values to understand the overall performance of our acoustic wall and ceiling products. The higher the NRC, the better the product is at soaking up the sound.

Performance Indices: Noise Reduction Coefficient (NRC) results represent the absorption coefficients measured at the one third octave bands at 125, 250, 500, 1000, 2000 and 4000 Hz rounded to the nearest 0.05. Acoustic testing has been performed according to the methods mentioned above. Customization of installation of the product could alter the results. Sound Absorption Average (SAA) indicates the absorption coefficient average for the twelve one-third octave bands ranging between 200 and 2500 Hz.

 For questions or additional product information, visit [acoufelt.com](https://www.acoufelt.com) or call **800.966.8557**.

Fracture Wall Panels | March 2026