

Tessera, Dimple Ceiling Tiles

Premier Collection

Bring dimension and performance to your ceiling with Tessera, Dimple. Each tile features a concave circle creating a rhythmic play of light and shadow that adds depth, texture, and visual intrigue. Designed to integrate into standard T-grid ceiling systems seamlessly, Dimple not only enhances the aesthetic of a space but also elevates the acoustic experience. Ideal for environments where focus, creativity, and collaboration matter, Dimple delivers form and function in one sophisticated solution.

Specifications

Surface	Ceiling	
Material	FilaSorb™ polyester felt	
Weight	0.49 lb./ft ² (±10%)	
Standard Sizes	Height	Tile
	2.3" H	24" W x 24" L

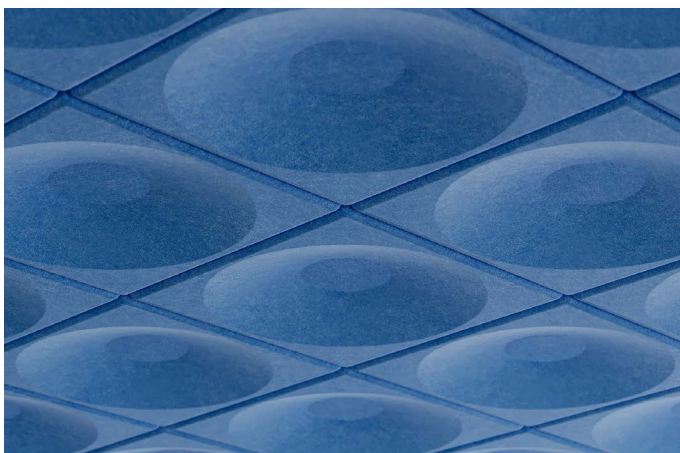

Tessera, Dimple Ceiling Tiles in Marine



Tessera, Dimple Ceiling Tiles with lighting cutout shown

* Any lighting depicted in renderings is for illustrative purposes only and is not included with the product. All lighting must be specified and coordinated by the project lighting designer or electrical engineer.

Technical

NRC Rating	1.30*
Fire Test	ASTM E84, Class A CAN/ULC-S102 Flame spread index: 15 Smoke developed index: 200
Water Sorption	ASTM C1104-2019 (A Modified) Water sorbed by weight: 0.20% (based on a 12mm thick panel)
Colorfastness	ISO 105-B02, 6-7

* Rating is estimated based on similar product designs. Comparison NRC results available upon request

Details

Lead Time	3 - 6 weeks
Origin	Manufactured and assembled in the US
Warranty	Product: 20 years* Colorfastness: 20 years*

* Conditions apply

Environmental

Recycled Content	Minimum 60%
Energy	Generated using 40% solar energy
Indoor Air Quality	VOC less than/equal to 0.5mg/m ³
Recyclable	100%*
Certifications	Declare Certification - LBC Red List Free (third-party verified) SCS Global Indoor Advantage Gold

* PET is recyclable through participating partners



For questions or additional product information, visit acoufelt.com or call 800.966.8557.

Tessera, Dimple Ceiling Tiles | January 2026

Colorways

PREMIER

							
White WH12	Milkyway MI74	Ivory IV11	Pearl PE21	Valentine VA70	Quartz QU67	Stonewash ST72	Sea Salt SE57
							
Platinum PL04	Almond AL55	Pistachio PI25	Turmeric TU60	Flamingo FL61	Amethyst AM69	Periwinkle PE23	Peacock PE20
							
Metal ME03	Mushroom MU75	Celery CE65	Wheat WH68	Peach PE19	Lilac LI13	Marine MA15	Sencha SE58
							
Grey GR02	Umber UM54	Wasabi WA29	Popcorn PO26	Currant CU59	Berry BE06	Azure AZ05	Oregano OR18
							
Charcoal CH01	Walnut WA56	Eucalyptus EU71	Carrot CA08	Loganberry LO77	Granite GR62	Denim DE09	Kale KA12
							
Piano Black PI24	Slate SL27	Nori NO76	Peppercorn PE22	Shiraz SH63	Flint FL64	Midnight MI16	

Order samples at acoufelt.com/colorways

 For questions or additional product information, visit acoufelt.com or call 800.966.8557.

Tessera, Dimple Ceiling Tiles | January 2026

Sizes

Standard Sizes	Height	Tile
	2.3" H	24" W x 24" L

Perspective

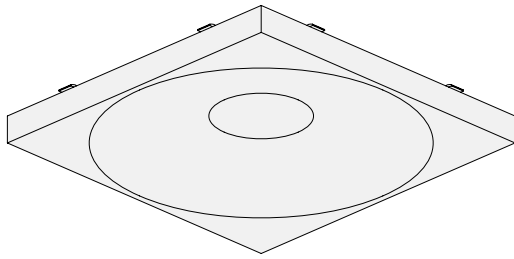

Plan

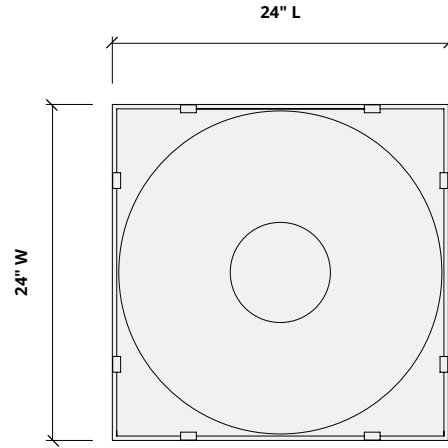

Elevations

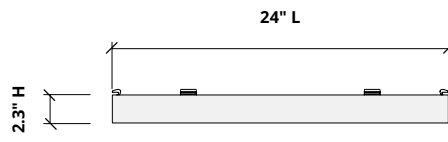
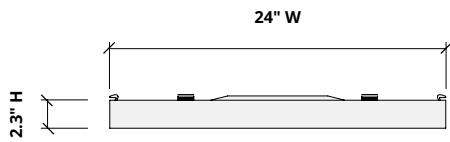

How to Specify

1. Choose Panel Pattern

2. Choose Colorways

Select desired panel pattern. See Tessera, Fragment and Facet sheets for additional information.

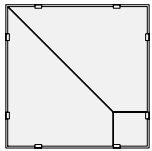

FRAGMENT

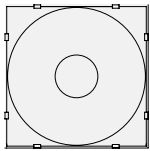

DIMPLE

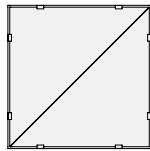

FACET

1. Choose Panel Pattern

2. Choose Colorways

See colorway choices on page 3.

Mounting Methods

Direct to 15/16" T-grid

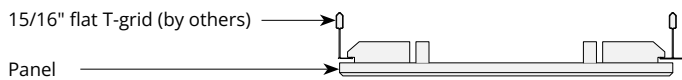

Acoustic Performance

Test Method	ASTM C423-23
Mounting Method	Type E-560
Test Results	NRC 1.30 SAA 1.30

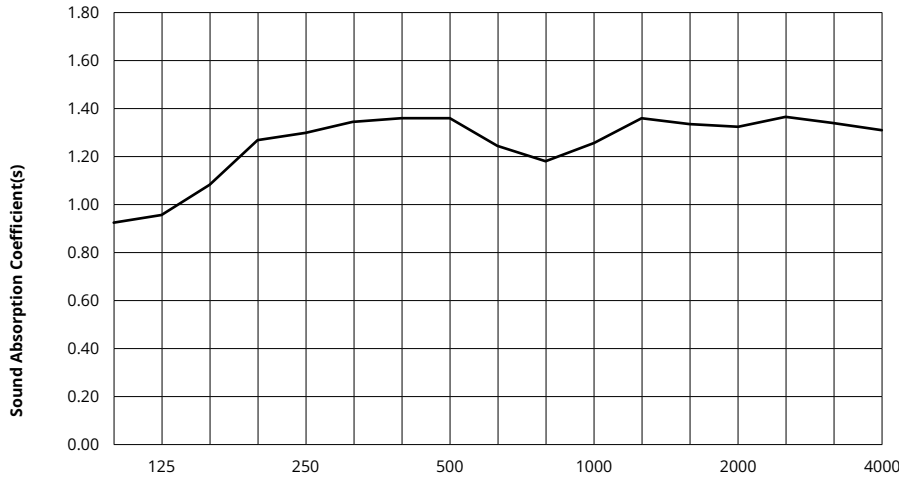

Frequency f (Hz)	125	250	500	1000	2000	4000	NRC
12mm	0.98	1.27	1.35	1.24	1.33	1.33	1.30

What is a Noise Reduction Coefficient (NRC)?

You'll find the NRC rating in the specifications of all of our products. This acronym stands for Noise Reduction Coefficient, and is expressed as a single number, a rating that describes the degree to which acoustic products can absorb sound.

You can use NRC values to understand the overall performance of our acoustic wall and ceiling products. The higher the NRC, the better the product is at soaking up the sound.

Performance Indices: Noise Reduction Coefficient (NRC) results represent the absorption coefficients measured at the one third octave bands at 125, 250, 500, 1000, 2000 and 4000 Hz rounded to the nearest 0.05. Acoustic testing has been performed according to the methods mentioned above. Customization of installation of the product could alter the results. Sound Absorption Average (SAA) indicates the absorption coefficient average for the twelve one-third octave bands ranging between 200 and 2500 Hz.

 For questions or additional product information, visit [acoufelt.com](https://www.acoufelt.com) or call **800.966.8557**.

Tessera, Dimple Ceiling Tiles | January 2026