



Pixel

Ceiling Panels

Premier Collection

Pixel is a double-layer acoustic panel that pairs minimalist design with maximum impact. Precision-cut patterns in the face of the outer felt layer reveal a contrasting second layer beneath to create depth, texture, and visual interest. Classic shapes add color and dimension while delivering premium sound absorption. Choose any two colors from the Premier palette to customize your Pixel pattern.

Specifications

Surface	Ceiling
Material	FilaSorb™ polyester felt
Weight	14mm, 0.49 lb./ft ² (±10%) 26mm, 0.98 lb./ft ² (±10%)
Standard Sizes	Width: 24", 48" W Length: 24", 48" and 96" L

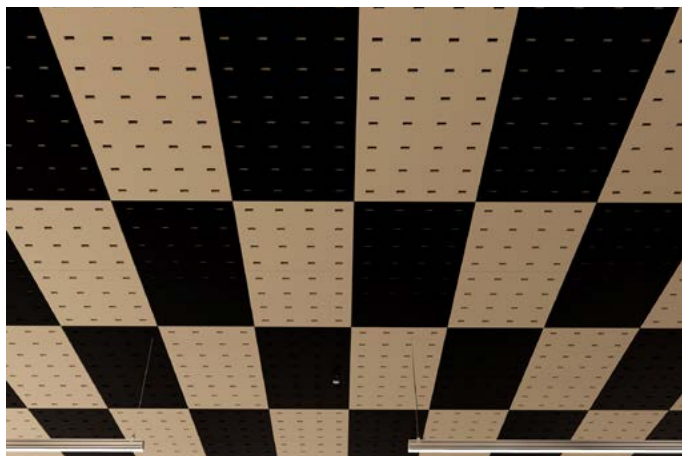

Pixel Ceiling Panel with Rectangle Pattern in Flint and Almond

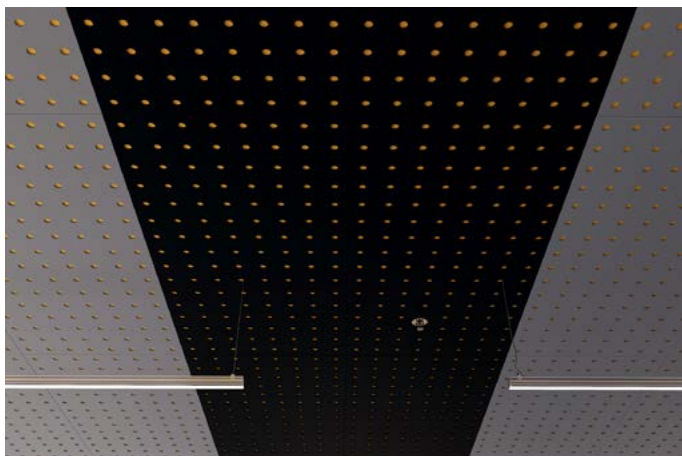

Pixel Ceiling Panel with Circle Pattern in Midnight, Periwinkle and Wheat

Technical

NRC Rating	14mm* 0.55, no air gap 0.70, 20mm air gap 0.75, 50mm air gap 26 mm* 0.60, no air gap
Fire Test	ASTM E84, Class A CAN/ULC-S102 Flame spread index: 15 Smoke developed index: 200
Water Sorption	ASTM C1104-2019 (A Modified) Water sorbed by weight: 0.20% (based on a 12mm thick panel)
Colorfastness	ISO 105-B02, 6-7

* Test results available upon request

Details

Lead Time	3 – 6 weeks
Origin	Manufactured and assembled in the US
Warranty	Product: 20 years* Colorfastness: 20 years*

* Conditions apply

Environmental

Recycled Content	Minimum 60%
Energy	Generated using 40% solar energy
Indoor Air Quality	VOC less than/equal to 0.5mg/m3
Recyclable	100%*
Certifications	Declare Certification - LBC Red List Free (third-party verified) SCS Global Indoor Advantage Gold

* PET is recyclable through participating partners



For questions or additional product information, visit [acoufelt.com](https://www.acoufelt.com) or call 800.966.8557.

Pixel Ceiling Panels | January 2026

Colorways

PREMIER



White
WH12



Milkyway
MI74



Ivory
IV11



Pearl
PE21



Valentine
VA70



Quartz
QU67



Stonewash
ST72



Sea Salt
SE57



Platinum
PL04



Almond
AL55



Pistachio
PI25

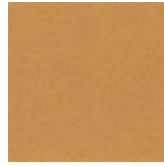

Turmeric
TU60



Flamingo
FL61



Amethyst
AM69



Periwinkle
PE23



Peacock
PE20



Metal
ME03



Mushroom
MU75



Celery
CE65



Wheat
WH68



Peach
PE19

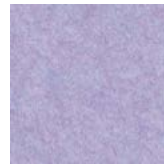

Lilac
LI13



Marine
MA15



Sencha
SE58



Grey
GR02



Umber
UM54



Wasabi
WA29

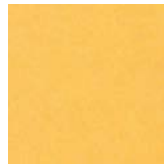

Popcorn
PO26

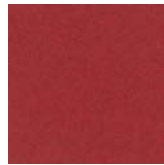

Currant
CU59



Berry
BE06



Azure
AZ05



Oregano
OR18



Charcoal
CH01



Walnut
WA56



Eucalyptus
EU71

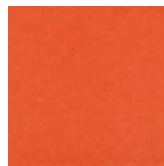

Carrot
CA08

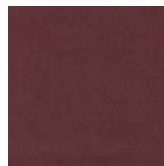

Loganberry
LO77

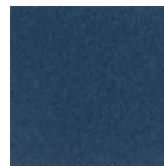

Granite
GR62

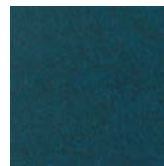

Denim
DE09



Kale
KA12



Piano Black
PI24



Slate
SL27



Nori
NO76

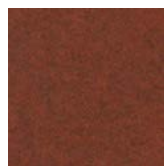

Peppercorn
PE22

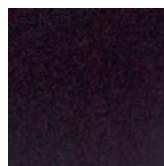

Shiraz
SH63

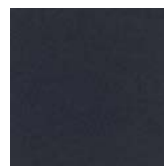

Flint
FL64

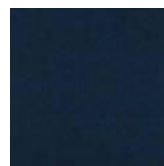

Midnight
MI16

Order samples at acoufelt.com/colorways



For questions or additional product information,
visit acoufelt.com or call **800.966.8557**.

Pixel Ceiling Panels | January 2026

Sizes

Standard Sizes

Width: 24", 48" W
Length: 24", 48" and 96" L

Plan

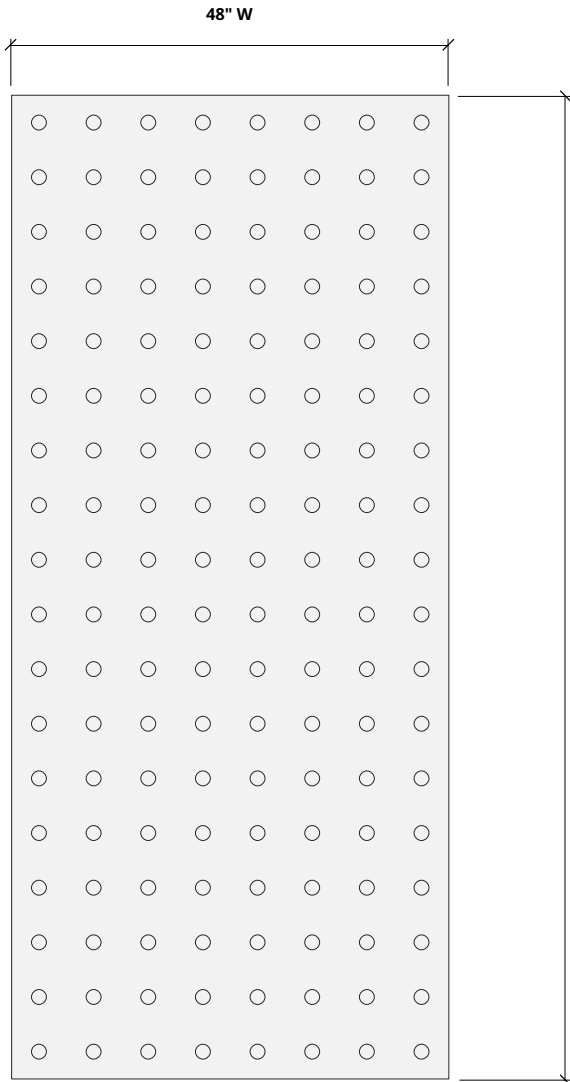

Perspective

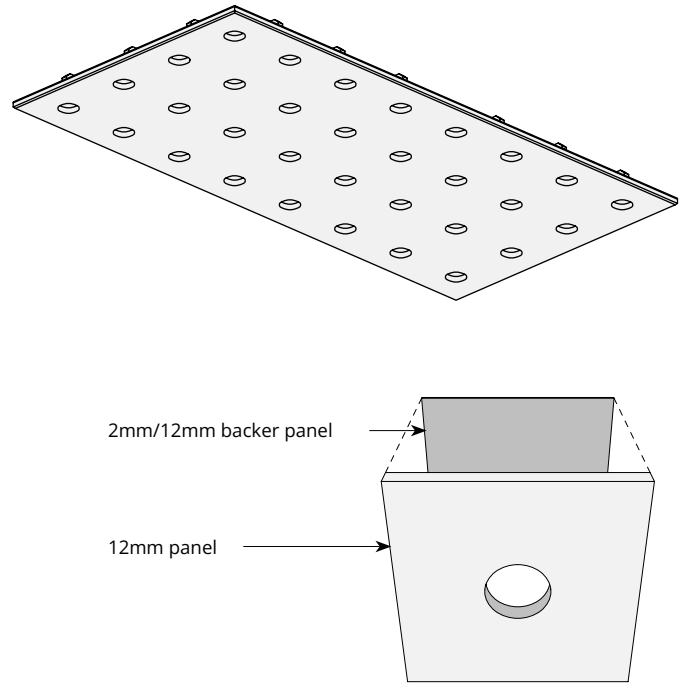

How to Specify

1. Choose Panel Design

2. Choose Sizes

3. Choose Colorways

Select desired panel design.

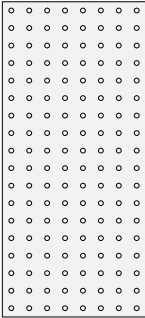

CIRCLE

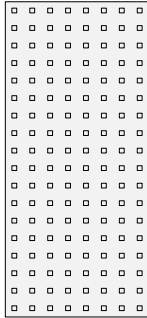

SQUARE

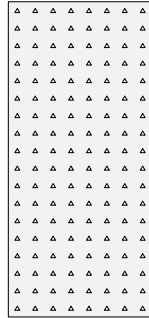

TRIANGLE

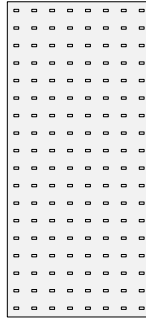

RECTANGLE

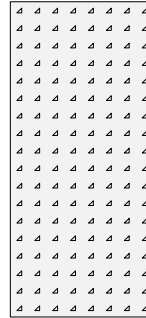

RIGHT TRIANGLE

1. Choose Panel Design

2. Choose Sizes

3. Choose Colorways

Select desired height and width.

1. Choose Panel Design

2. Choose Sizes

2. Choose Colorways

Select two colors: one for the face panel and one for the back panel to create a Pixel that is uniquely yours. See colorways on page 3.

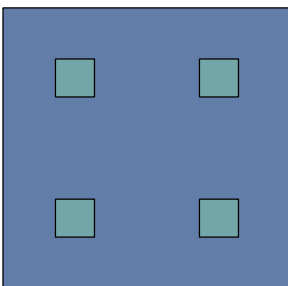

Square in Marine and Sea Salt

Mounting Methods

Direct to 15/16" T-grid

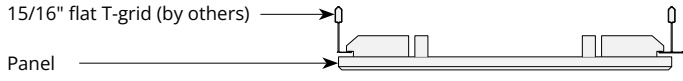

Acoustic Performance

Test Method	ISO 354-2006
Install Method	A
Rating Method	ISO 11654-2002
Test Results	<p>14mm NRC 0.55, no air gap NRC 0.70, 20mm air gap NRC 0.75, 50mm air gap SAA 0.56, no air gap SAA 0.70, 20mm air gap SAA 0.76 50mm air gap</p> <p>26mm NRC 0.60, no air gap</p>

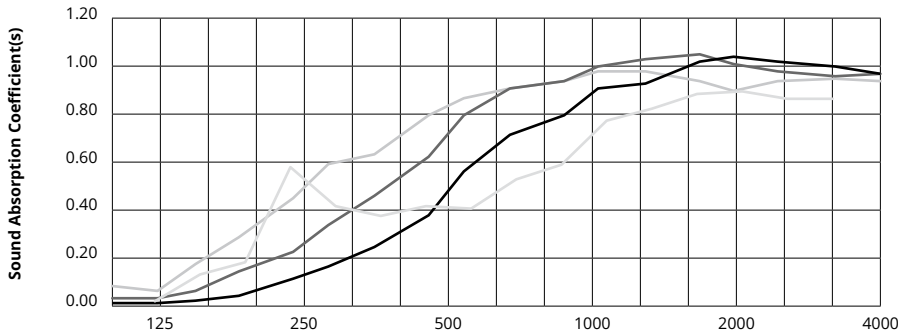

	Frequency f (Hz)	125	250	500	1000	2000	4000	NRC
	14mm	0.01	0.11	0.37	0.78	1.00	0.98	0.55
	14mm, 20mm air gap	0.03	0.22	0.61	0.93	1.03	0.94	0.70
	14mm, 50mm air gap	0.06	0.44	0.78	0.92	0.92	0.93	0.75
	26mm	0.02	0.57	0.41	0.58	0.87	0.85	0.60

What is a Noise Reduction Coefficient (NRC)?

You'll find the NRC rating in the specifications of all of our products. This acronym stands for Noise Reduction Coefficient, and is expressed as a single number, a rating that describes the degree to which acoustic products can absorb sound.

You can use NRC values to understand the overall performance of our acoustic wall and ceiling products. The higher the NRC, the better the product is at soaking up the sound.

Performance Indices: Noise Reduction Coefficient (NRC) results represent the absorption coefficients measured at the one third octave bands at 125, 250, 500, 1000, 2000 and 4000 Hz rounded to the nearest 0.05. Acoustic testing has been performed according to the methods mentioned above. Customization of installation of the product could alter the results. Sound Absorption Average (SAA) indicates the absorption coefficient average for the twelve one-third octave bands ranging between 200 and 2500 Hz.

 For questions or additional product information, visit [acoufelt.com](https://www.acoufelt.com) or call **800.966.8557**.

Pixel Ceiling Panels | January 2026