

## Woven, Gingham Ceiling Frames

Premier Collection

Woven's Gingham highlights a classic checkered pattern with evenly spaced, equal-sized vertical and horizontal lines, offering a timeless and structured aesthetic. Thoughtfully designed, it achieves an ideal balance of openness and acoustic performance while adding visual interest to any environment.

## Specifications

<b>Surface</b>	Ceiling	
<b>Material</b>	FilaSorb™ polyester felt	
<b>Weight</b>	0.49 lb./ft <sup>2</sup> (±10%)	
<b>Standard Sizes</b>	4" H x 24" W x 24" L 6" H x 24" W x 24" L	
<b>Compatible T-grid</b>	<b>Type</b>	<b>Layout</b>
	15/16" Flat	Standard 24" x 24"
	9/16" Flat	Standard 24" x 24"

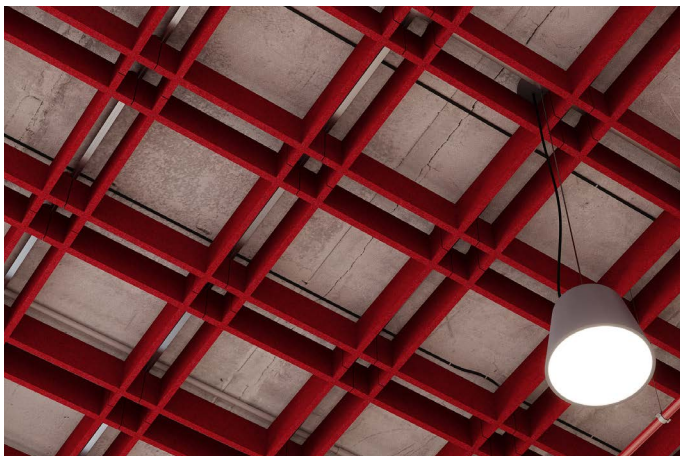

Woven, Gingham Ceiling Frames in Currant

## Technical

<b>NRC Rating</b>	Pending product testing
<b>Fire Test</b>	ASTM E84, Class A Flame spread index: 15 Smoke developed index: 200
<b>Water Sorption</b>	ASTM C1104-2019 (A Modified) Water sorbed by weight: 0.20% (based on a 12mm thick panel)
<b>Colorfastness</b>	ISO 105-B02, 6-7

## Details

<b>Lead Time</b>	3 – 6 weeks
<b>Origin</b>	Manufactured and assembled in the US
<b>Warranty</b>	Product: 20 years* Colorfastness: 20 years*

\* Conditions apply

## Environmental

<b>Recycled Content</b>	Minimum 60%
<b>Energy</b>	Generated using 40% solar energy
<b>Indoor Air Quality</b>	VOC less than/equal to 0.5mg/m <sup>3</sup>
<b>Recyclable</b>	100%*
<b>Certifications</b>	Declare Certification - LBC Red List Free (third-party verified) SCS Global Indoor Advantage Gold

\* PET is recyclable through participating partners.



For questions or additional product information, visit [acoufelt.com](https://www.acoufelt.com) or call 800.966.8557.

Woven, Gingham Ceiling Frames | January 2026

# Colorways

## PREMIER

							
White WH12	Milkyway MI74	Ivory IV11	Pearl PE21	Valentine VA70	Quartz QU67	Stonewash ST72	Sea Salt SE57
							
Platinum PL04	Almond AL55	Pistachio PI25	Turmeric TU60	Flamingo FL61	Amethyst AM69	Periwinkle PE23	Peacock PE20
							
Metal ME03	Mushroom MU75	Celery CE65	Wheat WH68	Peach PE19	Lilac LI13	Marine MA15	Sencha SE58
							
Grey GR02	Umber UM54	Wasabi WA29	Popcorn PO26	Currant CU59	Berry BE06	Azure AZ05	Oregano OR18
							
Charcoal CH01	Walnut WA56	Eucalyptus EU71	Carrot CA08	Loganberry LO77	Granite GR62	Denim DE09	Kale KA12
							
Piano Black PI24	Slate SL27	Nori NO76	Peppercorn PE22	Shiraz SH63	Flint FL64	Midnight MI16	

Order samples at [acoufelt.com/colorways](https://acoufelt.com/colorways)



For questions or additional product information, visit [acoufelt.com](https://acoufelt.com) or call 800.966.8557.

Woven, Gingham Ceiling Frames | January 2026

# How to Specify

## 1. Choose Slat Height

## 2. Choose Colorways

Slats are available in two heights:

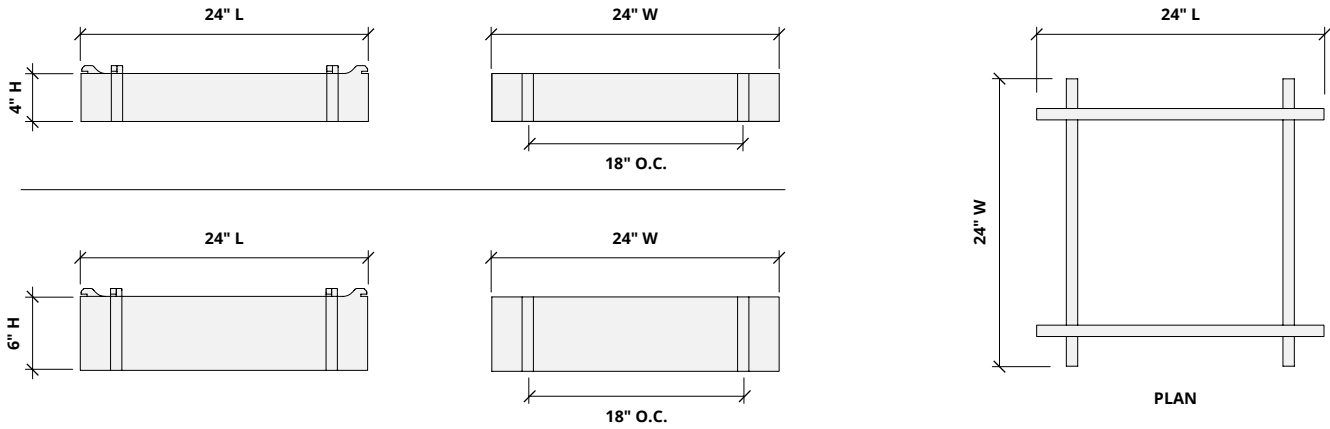

## 1. Choose Slat Height

## 2. Choose Colorways

See colorway choices on page 3.

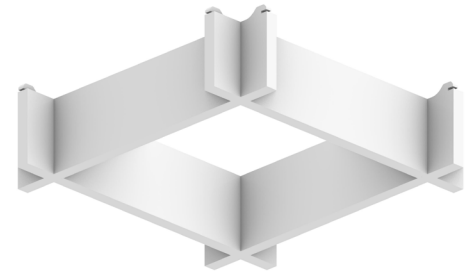

# Lighting Coordination

24" x 24" Grid light

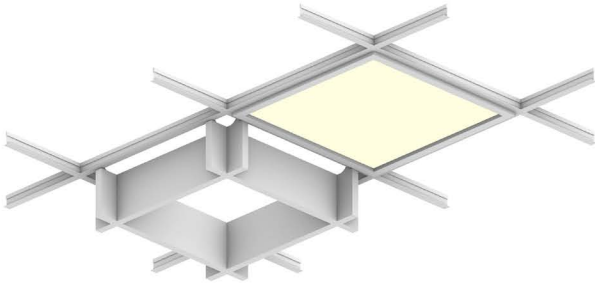

Drop pendant light

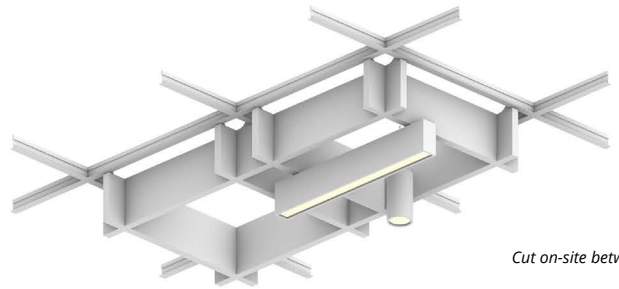

Recessed light

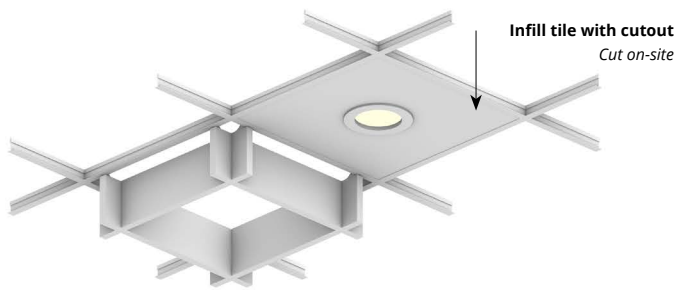

# Acoustic Performance

<b>Test Method</b>	ASTM E795
<b>Install Method</b>	Type E-400
<b>Rating Method</b>	ASTM C423
<b>Mounting Method</b>	2" W x 3" H slat on 12mm backer with 400mm air gap
<b>Test Results</b>	NRC 0.95 SAA 0.96

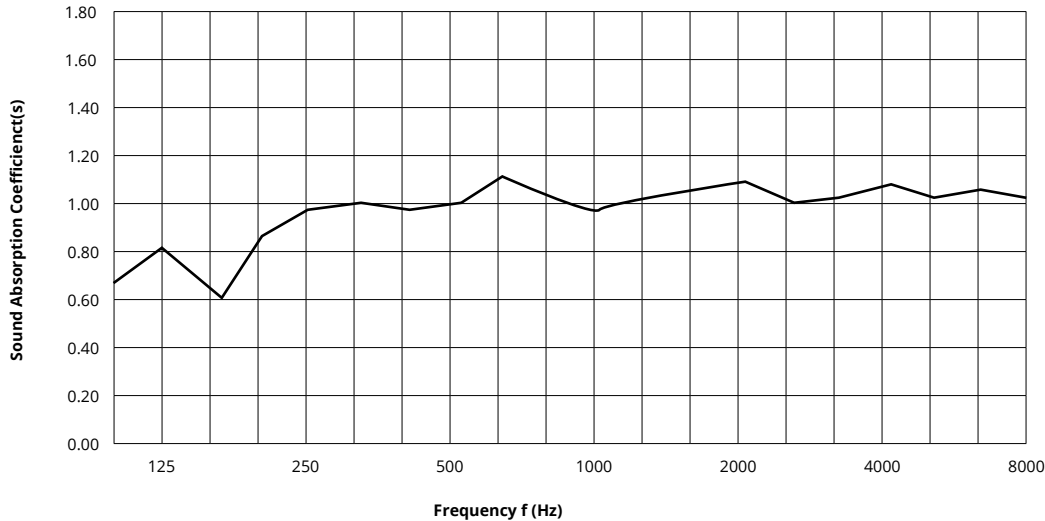

Frequency f (Hz)	125	250	500	1000	2000	4000	NRC
12mm	0.67	0.86	0.96	1.02	1.04	1.00	0.95

## What is a Noise Reduction Coefficient (NRC)?

You'll find the NRC rating in the specifications of all of our products. This acronym stands for Noise Reduction Coefficient, and is expressed as a single number, a rating that describes the degree to which acoustic products can absorb sound.

You can use NRC values to understand the overall performance of our acoustic wall and ceiling products. The higher the NRC, the better the product is at soaking up the sound.

*Performance Indices: Noise Reduction Coefficient (NRC) results represent the absorption coefficients measured at the one third octave bands at 125, 250, 500, 1000, 2000 and 4000 Hz rounded to the nearest 0.05. Acoustic testing has been performed according to the methods mentioned above. Customization of installation of the product could alter the results. Sound Absorption Average (SAA) indicates the absorption coefficient average for the twelve one-third octave bands ranging between 200 and 2500 Hz.*

 For questions or additional product information, visit [acoufelt.com](http://acoufelt.com) or call **800.966.8557**.

Woven, Gingham Ceiling Frames | January 2026