

Vista, Desert Wall Tiles

Premier Collection

Evenly arranged cubes of the Vista, Desert Wall Tiles design mimic a calming, open expanse of land while ensuring superior sound management. Choose a single Premier color option or mix two complementary colors for the cubes and the backing. Modern, modular, and easy to install, Vista can change your outlook about working or meeting in a crowded space.

Specifications

Surface	Wall	
Material	FilaSorb™ polyester felt	
Weight	0.49 lb./ft ² (±10%)	
Standard Sizes	Depth	Backer Panels
	3, 6" D	24" W x 24" L 24" W x 48" L 24" W x 96" L



Vista, Desert Wall Tile in White and Almond

Technical

NRC Rating	Pending product testing
Fire Test	ASTM E84, Class A CAN/ULC-S102 Flame spread index: 15 Smoke developed index: 200
Water Sorption	ASTM C1104-2019 (A Modified) Water sorbed by weight: 0.20% (based on a 12mm thick panel)
Colorfastness	ISO 105-B02, 6-7

Details

Lead Time	3 – 6 weeks
Origin	Manufactured and assembled in the US
Warranty	Product: 20 years* Colorfastness: 20 years*

* Conditions apply

Environmental

Recycled Content	Minimum 60%
Energy	Generated using 40% solar energy
Indoor Air Quality	VOC less than/equal to 0.5mg/m ³
Recyclable	100%*
Certifications	Declare Certification - LBC Red List Free (third-party verified) SCS Global Indoor Advantage Gold

* PET is recyclable through participating partners



For questions or additional product information,
visit [acoufelt.com](https://www.acoufelt.com) or call **800.966.8557**.

Vista, Desert Wall Panels | January 2026

Colorways

PREMIER



White
WH12



Milkyway
MI74



Ivory
IV11



Pearl
PE21



Valentine
VA70



Quartz
QU67



Stonewash
ST72



Sea Salt
SE57



Platinum
PL04



Almond
AL55



Pistachio
PI25

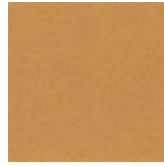

Turmeric
TU60



Flamingo
FL61



Amethyst
AM69



Periwinkle
PE23



Peacock
PE20



Metal
ME03



Mushroom
MU75



Celery
CE65



Wheat
WH68



Peach
PE19

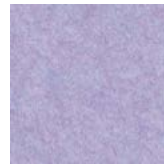

Lilac
LI13



Marine
MA15



Sencha
SE58



Grey
GR02



Umber
UM54



Wasabi
WA29

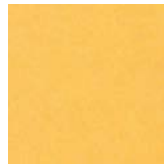

Popcorn
PO26

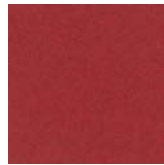

Currant
CU59



Berry
BE06



Azure
AZ05



Oregano
OR18



Charcoal
CH01



Walnut
WA56



Eucalyptus
EU71

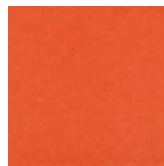

Carrot
CA08

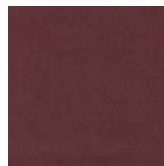

Loganberry
LO77

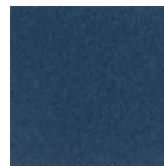

Granite
GR62

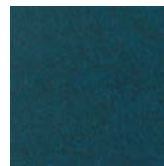

Denim
DE09



Kale
KA12

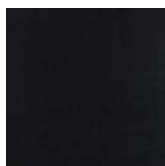

Piano Black
PI24



Slate
SL27



Nori
NO76

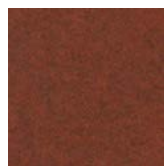

Peppercorn
PE22

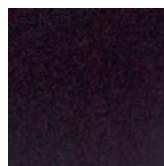

Shiraz
SH63

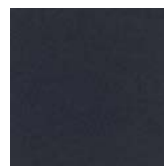

Flint
FL64

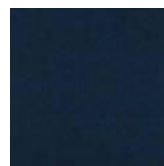

Midnight
MI16

Order samples at acoufelt.com/colorways

 For questions or additional product information, visit acoufelt.com or call 800.966.8557.

Vista, Desert Wall Panels | January 2026

How to Specify

1. Choose Cube Depth

2. Choose Tile Size

3. Choose Colorway

Tiles are available in two cube depths.

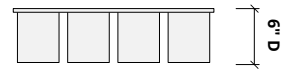

1. Choose Cube Depth

2. Choose Tile Size

3. Choose Colorway

Tiles are available in three backer panel heights: 24, 48, and 96" H. All available in both 3" and 6" D.

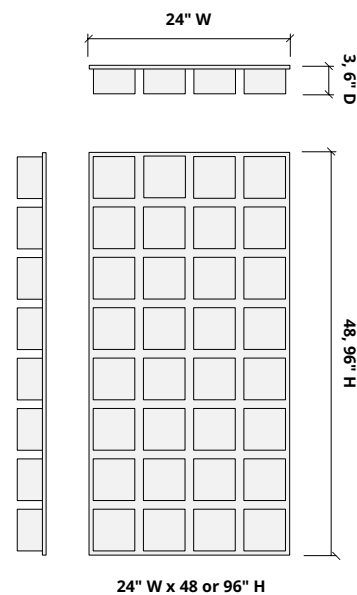
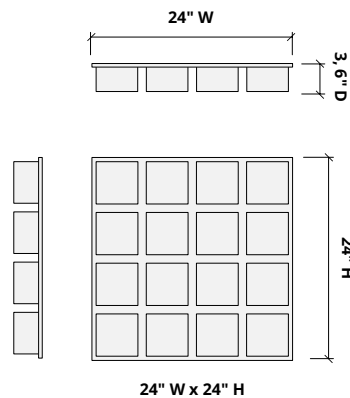

1. Choose Cube Depth

2. Choose Tile Size

3. Choose Colorway

Select one colorway for your cubes and one colorway for your backer panel, or one colorway for both. See colorway choices on page 3.

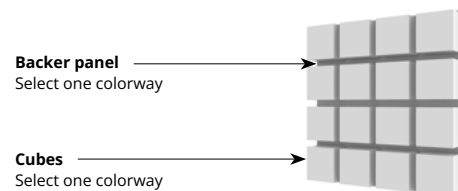

Mounting Methods

Adhesive backing

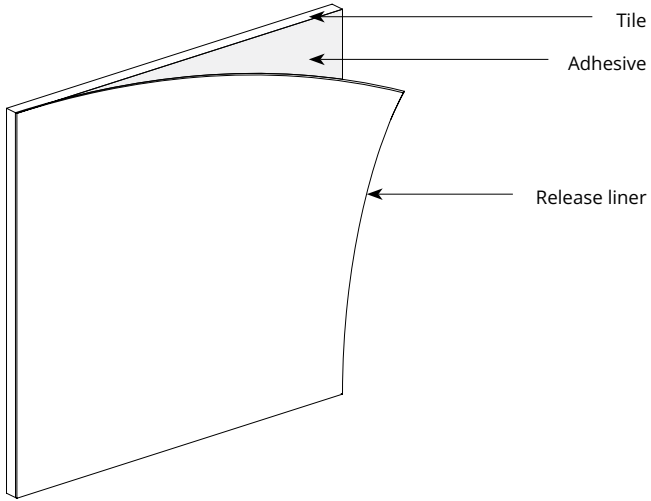

Construction adhesive

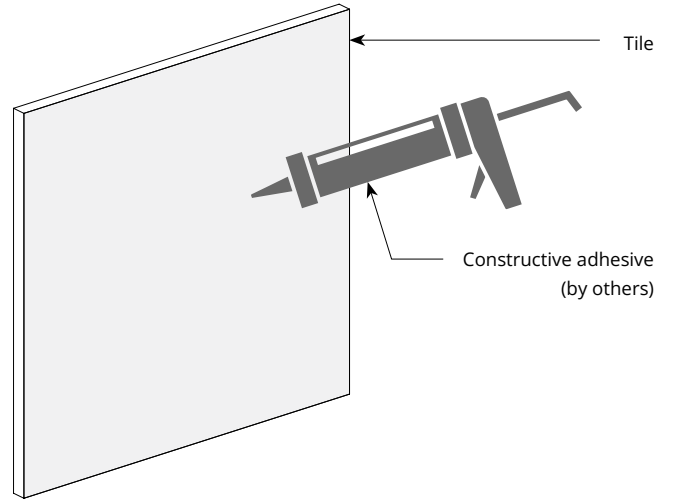

Acoustic Performance

Test Method	ASTM E795
Install Method	Type E-400
Rating Method	ASTM C423
Mounting Method	2" W x 3" H slat on 12mm backer with 400mm air gap
Test Results	NRC 0.95 SAA 0.96

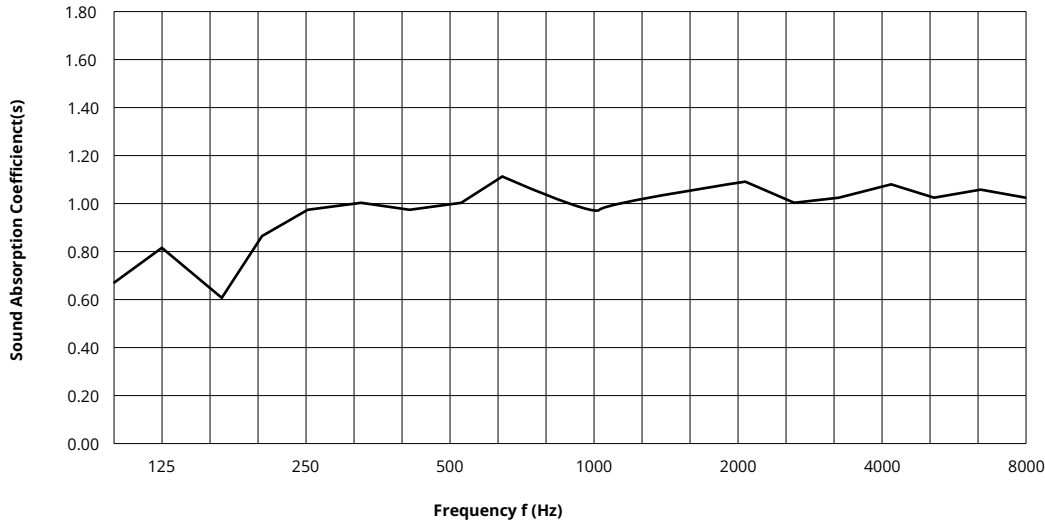

Frequency f (Hz)	125	250	500	1000	2000	4000	NRC
12mm	0.67	0.86	0.96	1.02	1.04	1.00	0.95

What is a Noise Reduction Coefficient (NRC)?

You'll find the NRC rating in the specifications of all of our products. This acronym stands for Noise Reduction Coefficient, and is expressed as a single number, a rating that describes the degree to which acoustic products can absorb sound.

You can use NRC values to understand the overall performance of our acoustic wall and ceiling products. The higher the NRC, the better the product is at soaking up the sound.

Performance Indices: Noise Reduction Coefficient (NRC) results represent the absorption coefficients measured at the one third octave bands at 125, 250, 500, 1000, 2000 and 4000 Hz rounded to the nearest 0.05. Acoustic testing has been performed according to the methods mentioned above. Customization of installation of the product could alter the results. Sound Absorption Average (SAA) indicates the absorption coefficient average for the twelve one-third octave bands ranging between 200 and 2500 Hz.

 For questions or additional product information, visit [acoufelt.com](https://www.acoufelt.com) or call **800.966.8557**.

Vista, Desert Wall Panels | January 2026