

Rail, Lines Ceiling Frames

WoodGrain Collection

Rail Ceiling Frames offer unmatched flexibility to craft unique, textured ceilings. With an open-tile design and the absence of a backer, Rail seamlessly integrates with essential ceiling components like lighting, sprinklers, and speakers.

The Rail frames system ensures hassle-free installation with its innovative click-in design, eliminating the need for additional hardware. Fully compatible with standard 15/16" T-grid drop ceilings, it provides a versatile and efficient solution for modern ceiling designs.

Specifications

Surface	Ceiling	
Material	FilaSorb™ polyester felt	
Weight	0.49 lb./ft ² (±10%) 0.98 lb./ft ² (±10%)	
Standard Sizes	24" W x 24" L x 4" H 24" W x 24" L x 6" H 24" W x 48" L x 4" H 24" W x 48" L x 6" H	
Compatible T-grid	Type	Layout
	15/16" Flat	Standard 24" x 24"
	9/16" Flat	Standard 24" x 24"

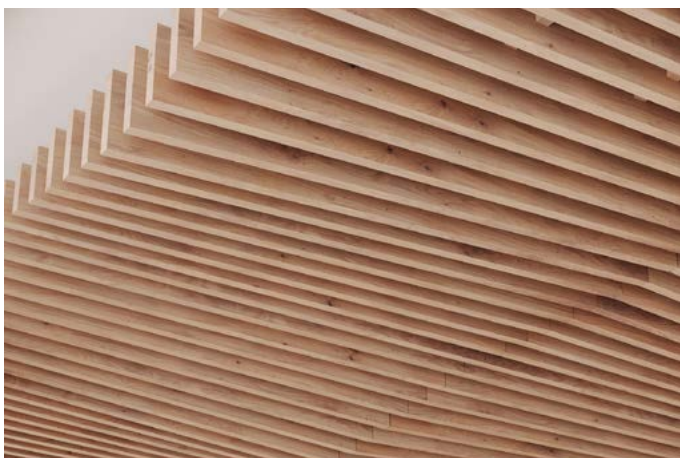

Rail, Lines Ceiling Frames in Fumed Oak

Technical

NRC Rating	Pending product testing
Fire Test	ASTM E84, Class A Flame spread index: 15 Smoke developed index: 200
Water Sorption	ASTM C1104-2019 (A Modified) Water sorbed by weight: 0.20% (based on a 12mm thick panel)
Colorfastness	ISO 105-B02, 6-7

Details

Lead Time	3 – 6 weeks
Origin	Manufactured and assembled in the US
Warranty	Product: 20 years* Colorfastness: 20 years*

* Conditions apply

Environmental

Recycled Content	Minimum 60%
Energy	Generated using 40% solar energy
Indoor Air Quality	VOC less than/equal to 0.5mg/m3
Recyclable	100%*
Certifications	Declare Certification - LBC Red List Free (third-party verified) SCS Global Indoor Advantage Gold

* PET is recyclable through participating partners.



For questions or additional product information, visit [acoufelt.com](https://www.acoufelt.com) or call **800.966.8557**.

Rail, Lines Ceiling Frames | February 2026

Colorways

WOODGRAIN



Picket Fence
WQ01



Loft
WQ06



White Elm
WQ07



Lyed Larch
WQ30



White Oak
WQ13



Baltic Birch
WQ12



Knotty Spruce
WQ29



French Bobbin
WQ08



Boat Shed
WQ02



Nordic Plank
WQ15



Boardwalk
WQ10



Mocha Legno
WQ25



Mountain Lodge
WQ24



Wine Barrel
WQ03



Log Cabin
WQ04



Natural Oak
WQ16



Woodland Fog
WQ22



Driftwood
WQ21



Weathered Slate
WQ14



Petrified Ash
WQ23



Antique Chest
WQ11



European Larch
WQ17



Fumed Oak
WQ19



Teak
WQ18



Charred Larch
WQ09



Shadow Oak
WQ28



Barn Door
WQ05



Black Walnut
WQ20



Scorched Timber
WQ26



Espresso Oak
WQ27

Order samples at acoufelt.com/colorways

How to Specify

1. Choose Slat Height

2. Choose Tile Size

3. Choose Colorway

Slats are available in two overall heights:

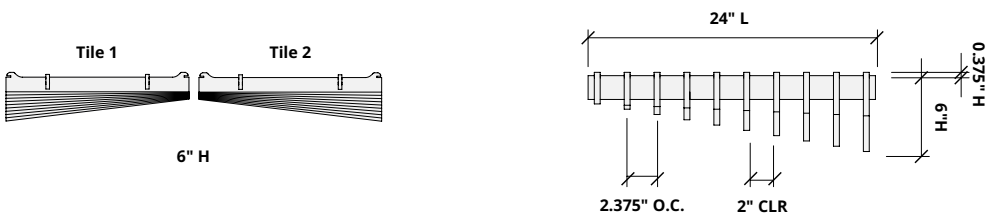
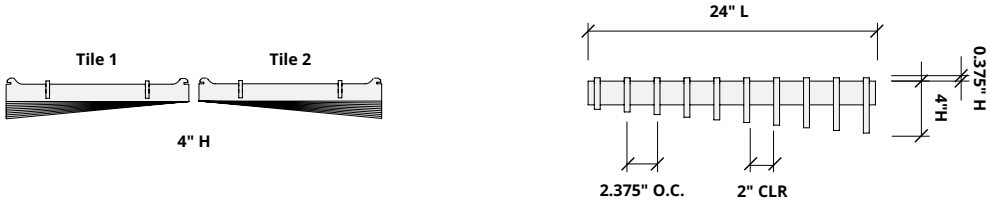

1. Choose Slat Height

2. Choose Tile Size

3. Choose Colorway

Ties are available in two sizes for use with 4 inch H and 6 inch H slats.

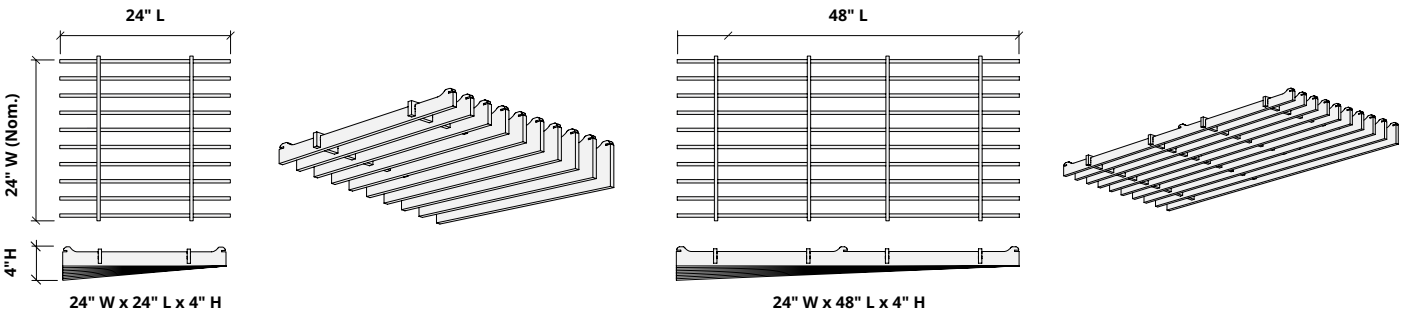

1. Choose Slat Height

2. Choose Tile Size

3. Choose Colorway

Select one colorway for your tile. See colorway choices on page 3.

Recommended Layouts

Layout 1

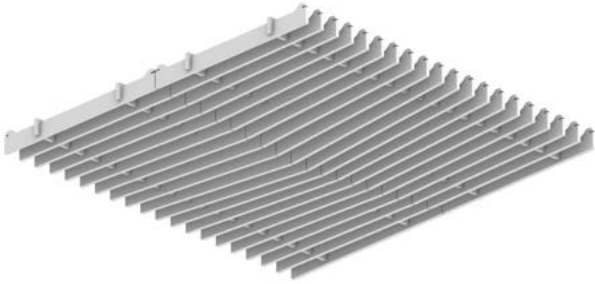

Lighting Coordination

2' x 2', 2' x 4' Grid light

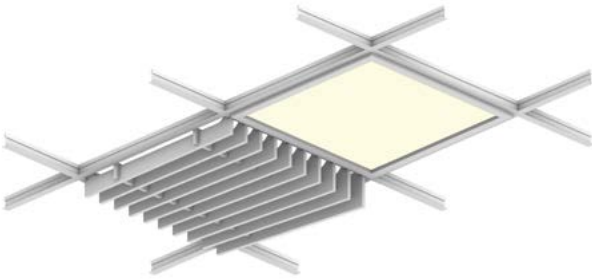

Drop pendant light

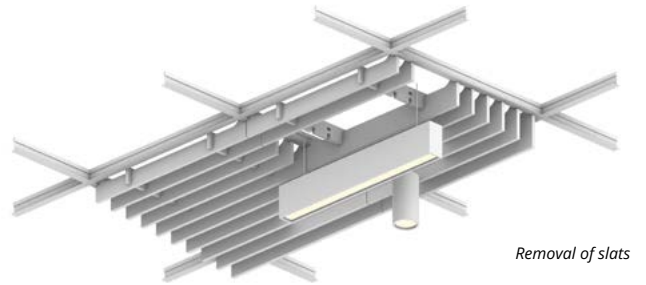

Recessed light

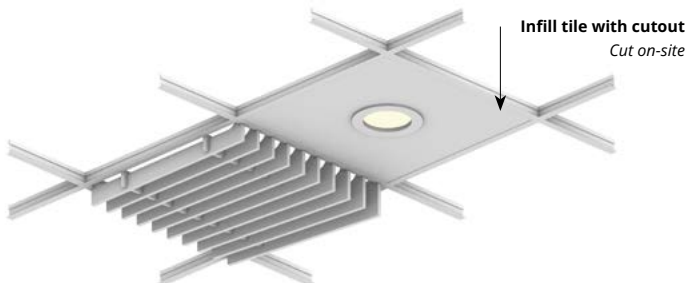

Grid mounted light (track, pendant)

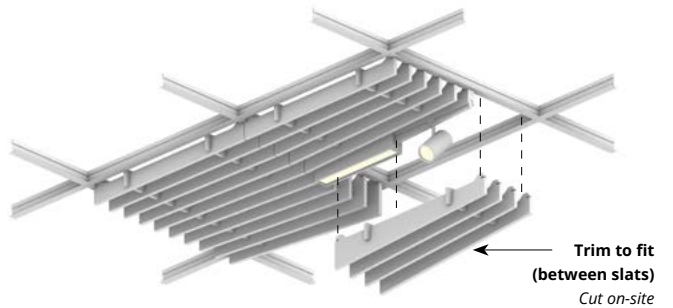

Acoustic Performance

Test Method	ASTM E795
Install Method	E-400
Rating Method	ASTM C423-17
Mounting Method	
Test Results	Pending product testing

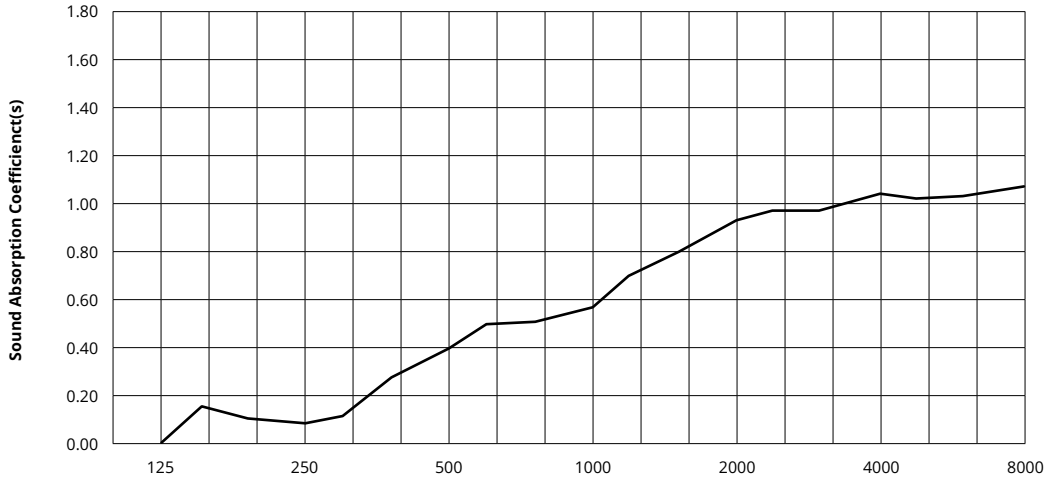

Frequency f (Hz)	125	250	500	1000	2000	4000	8000	NRC
12mm	Pending product testing							

What is a Noise Reduction Coefficient (NRC)?

You'll find the NRC rating in the specifications of all of our products. This acronym stands for Noise Reduction Coefficient, and is expressed as a single number, a rating that describes the degree to which acoustic products can absorb sound.

You can use NRC values to understand the overall performance of our acoustic wall and ceiling products. The higher the NRC, the better the product is at soaking up the sound.

Performance Indices: Noise Reduction Coefficient (NRC) results represent the absorption coefficients measured at the one third octave bands at 125, 250, 500, 1000, 2000 and 4000 Hz rounded to the nearest 0.05. Acoustic testing has been performed according to the methods mentioned above. Customization of installation of the product could alter the results. Sound Absorption Average (SAA) indicates the absorption coefficient average for the twelve one-third octave bands ranging between 200 and 2500 Hz.

 For questions or additional product information, visit acoufelt.com or call **800.966.8557**.

Rail, Lines Ceiling Frames | February 2026