

Spine Wall Panels

Premier Collection

Spine Wall Panels showcase an innovative three-dimensional design, combining Premier sound-absorbing panels with elevated patterns seamlessly layered for a striking visual effect. The variety of bold shapes and colors allows for developing dynamic aesthetics and enhances the depth and interest of any interior. The panels can be rotated to form customized patterns, enabling configurations that range from minimalist elegance to eye-catching layouts. This versatile solution blends natural warmth with modern design to deliver a distinctive architectural statement while balancing functionality and character.

Specifications

Surface	Wall
Material	FilaSorb™ polyester felt
Weight	12mm, 0.49 lb./ft ² (±10%) 24mm, 0.98 lb./ft ² (±10%)
Standard Sizes	48" W x 108" H <i>Custom sizes available</i>



Spine Wall Panel with Bars A Pattern in Stonewash and Peach



Spine Wall Panel with Pipeline A Pattern in Currant and Sea Salt

Technical

NRC Rating	12mm* 0.45, no air gap 0.54, 12mm air gap 0.64, 20mm air gap 24mm* 0.60, no air gap
Fire Test	ASTM E84, Class A CAN/ULC-S102 Flame spread index: 15 Smoke developed index: 200
Water Sorption	ASTM C1104-2019 (A Modified) Water sorbed by weight: 0.20% (based on a 12mm thick panel)
Colorfastness	ISO 105-B02, 6-7

* Test results available upon request

Details

Lead Time	3 – 6 weeks
Origin	Manufactured and assembled in the US
Warranty	Product: 20 years* Colorfastness: 20 years*

* Conditions apply

Environmental

Recycled Content	Minimum 60%
Energy	Generated using 40% solar energy
Indoor Air Quality	VOC less than/equal to 0.5mg/m ³
Recyclable	100%*
Certifications	Declare Certification - LBC Red List Free (third-party verified) SCS Global Indoor Advantage Gold

* PET is recyclable through participating partners



For questions or additional product information, visit [acoufelt.com](https://www.acoufelt.com) or call **800.966.8557**.

Spine Wall Panels | January 2026

Colorways

PREMIER

							
White WH12	Milkyway MI74	Ivory IV11	Pearl PE21	Valentine VA70	Quartz QU67	Stonewash ST72	Sea Salt SE57
							
Platinum PL04	Almond AL55	Pistachio PI25	Turmeric TU60	Flamingo FL61	Amethyst AM69	Periwinkle PE23	Peacock PE20
							
Metal ME03	Mushroom MU75	Celery CE65	Wheat WH68	Peach PE19	Lilac LI13	Marine MA15	Sencha SE58
							
Grey GR02	Umber UM54	Wasabi WA29	Popcorn PO26	Currant CU59	Berry BE06	Azure AZ05	Oregano OR18
							
Charcoal CH01	Walnut WA56	Eucalyptus EU71	Carrot CA08	Loganberry LO77	Granite GR62	Denim DE09	Kale KA12
							
Piano Black PI24	Slate SL27	Nori NO76	Peppercorn PE22	Shiraz SH63	Flint FL64	Midnight MI16	

Order samples at acoufelt.com/colorways

 For questions or additional product information, visit acoufelt.com or call 800.966.8557.

Spine Wall Panels | January 2026

Sizes

Standard Sizes 48" W x 108" H
Custom sizes available

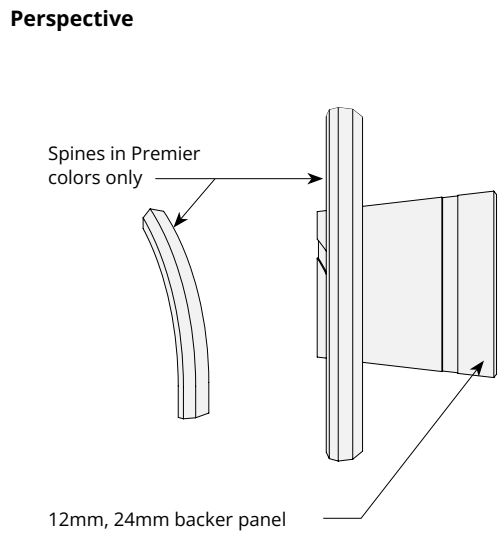
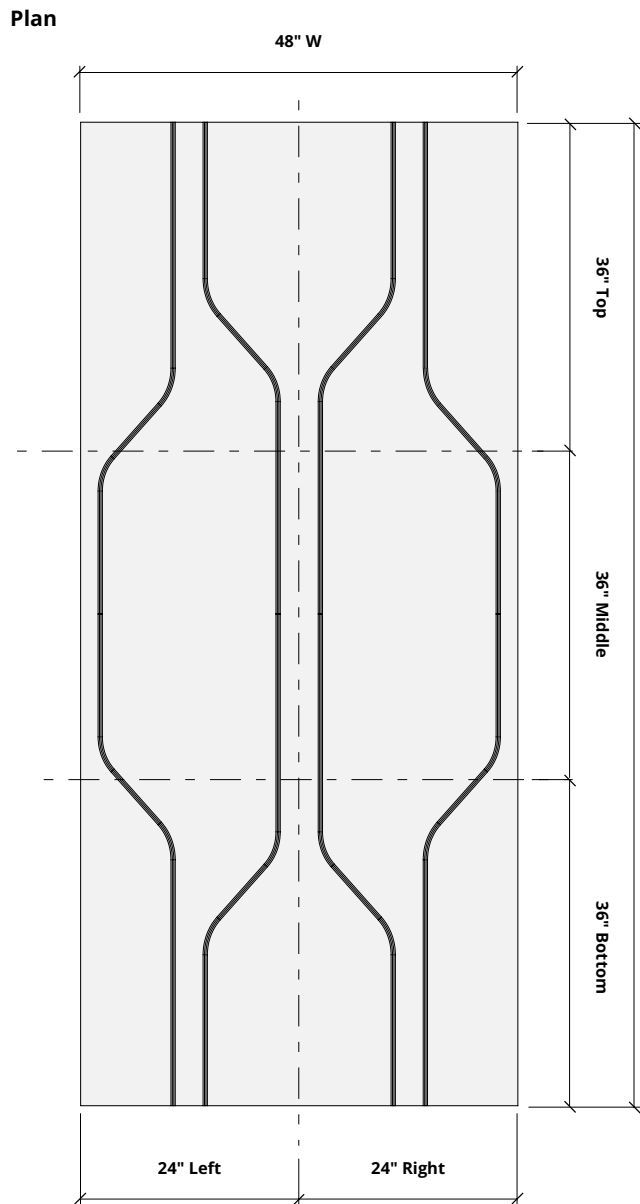

** Product available as full panels or as sections of a panel as filler pieces.
Choose any of the standard height or segments (i.e. bottom right, middle left, etc) to fill the space as needed.*

 For questions or additional product information, visit [acoufelt.com](https://www.acoufelt.com) or call 800.966.8557.

Spine Wall Panels | January 2026

How to Specify

1. Choose Panel Design

2. Choose Colorways

Select desired panel design. See recommended layouts for larger spaces. Multiple patterns can be specified together for a more dynamic design.

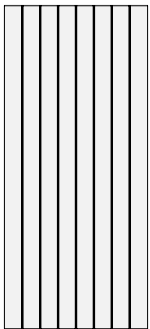

BARS A

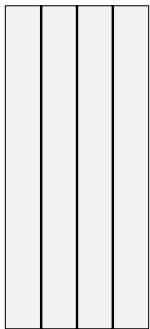

BARS B

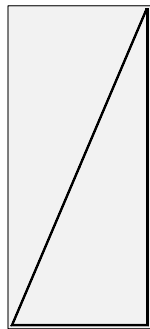

CLEAVE

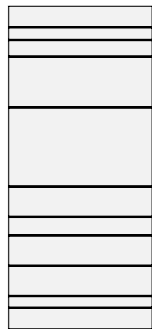

PANES A

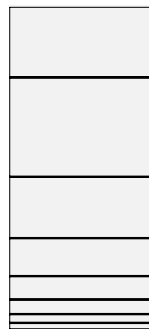

PANES B

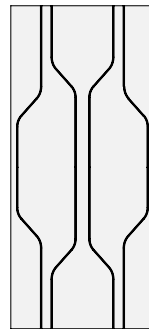

PIPELINE A

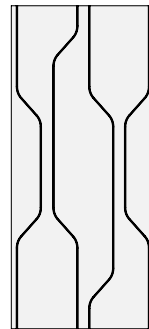

PIPELINE B

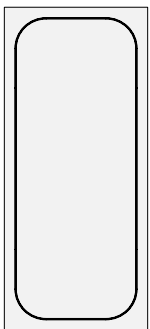

RACETRACK A

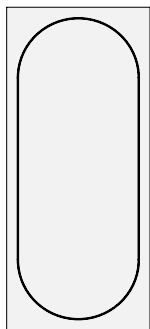

RACETRACK B

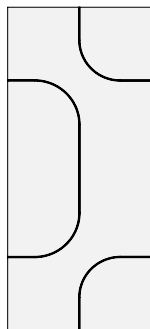

ROUNDABOUT

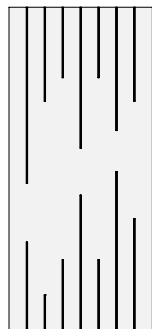

RULER

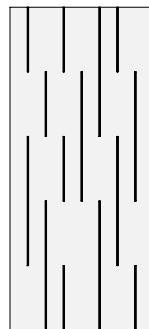

SCORED

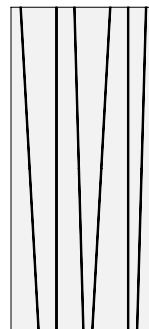

STEMS A

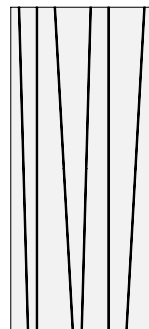

STEMS B

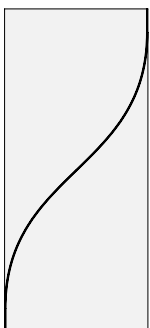

TULIP A

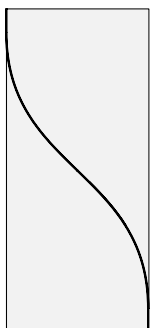

TULIP B

1. Choose Panel Design

2. Choose Colorways

See colorways on page 3.



For questions or additional product information, visit [acoufelt.com](https://www.acoufelt.com) or call 800.966.8557.

Spine Wall Panels | January 2026

Recommended Layouts

Bars A

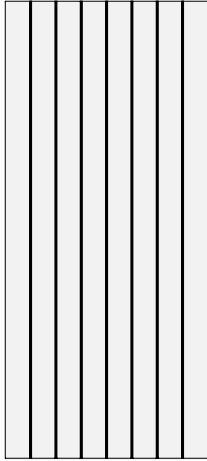

Layout 1

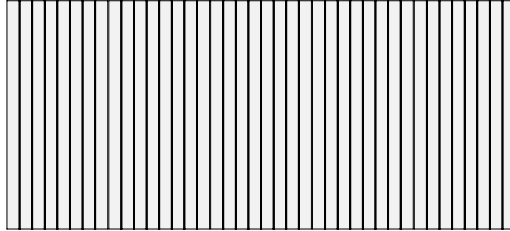

Layout 2

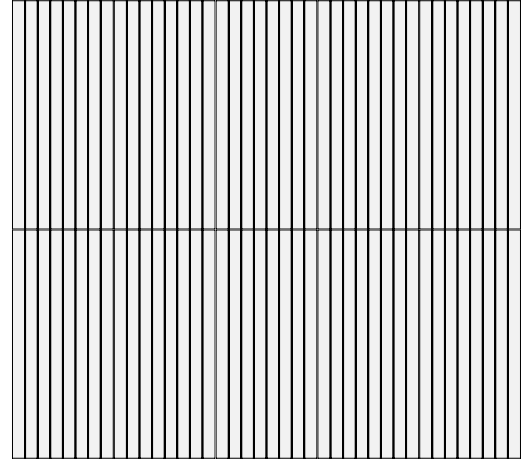

Bars B

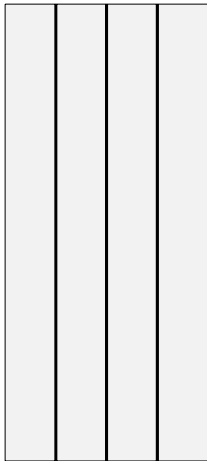

Layout 1

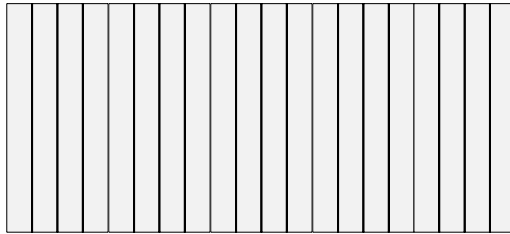

Layout 2

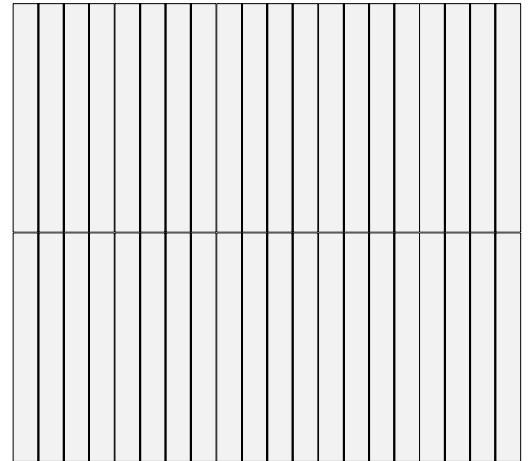

Recommended Layouts

Cleave

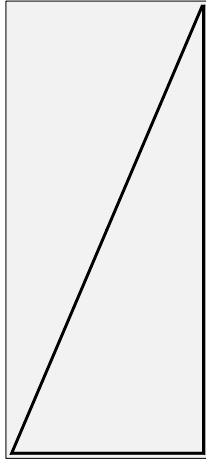

Layout 1

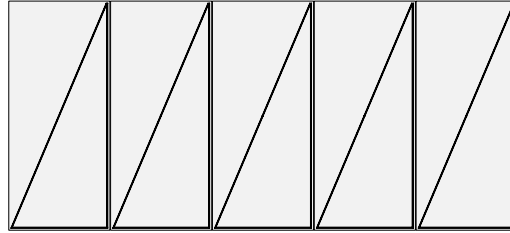

Layout 2

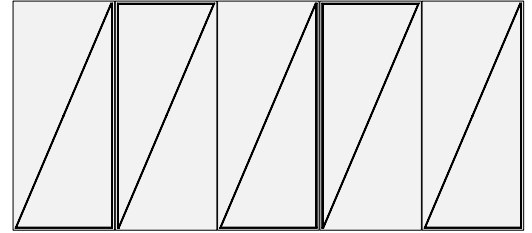

Layout 3

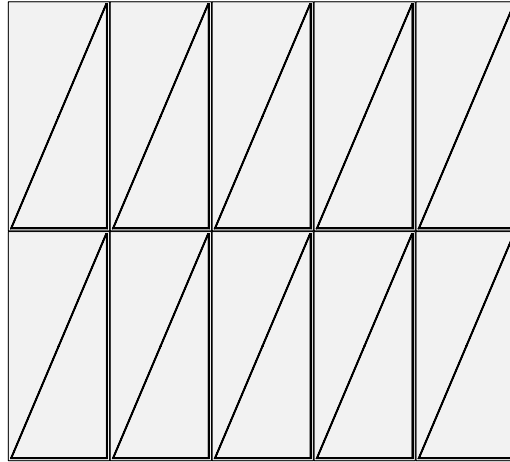

Layout 4

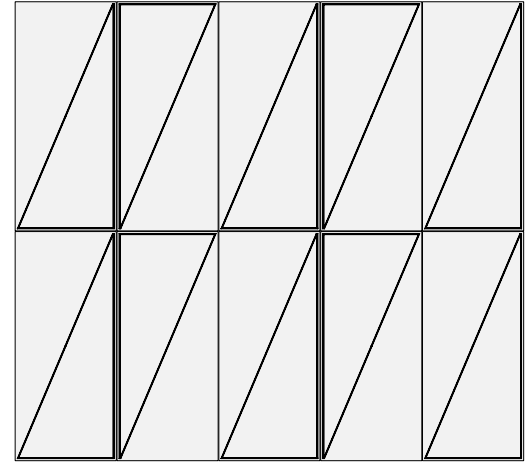

Recommended Layouts

Panes A



Layout 1

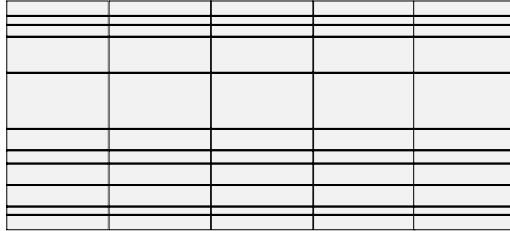

Layout 2

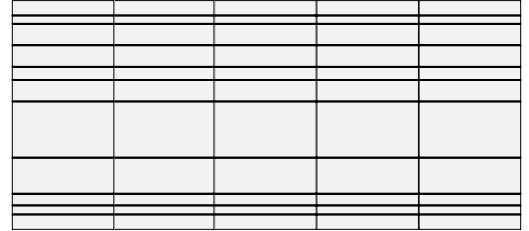

Layout 3

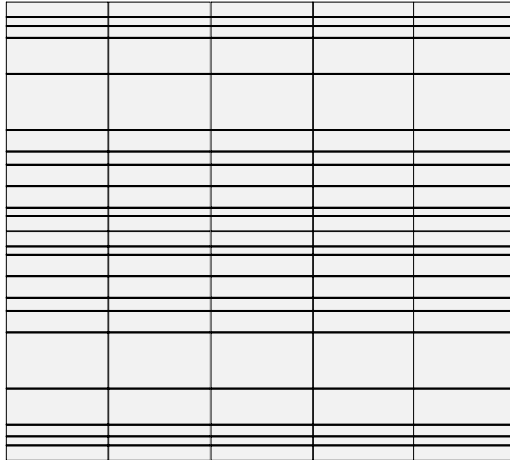

Layout 4

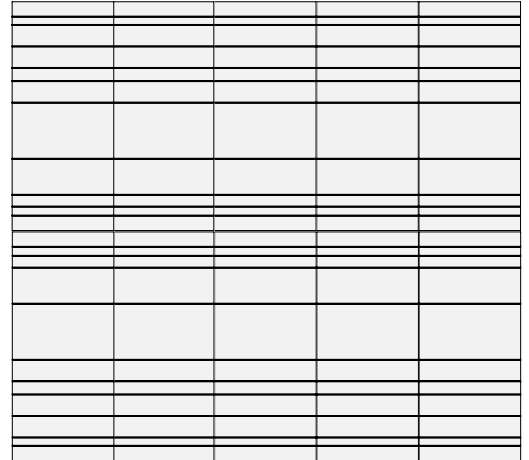

Recommended Layouts

Panes B



Layout 1

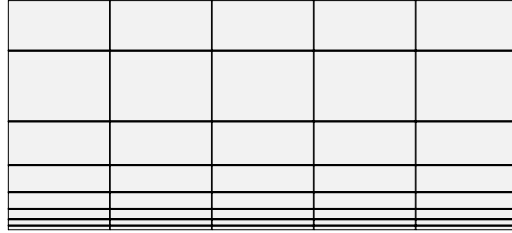

Layout 2

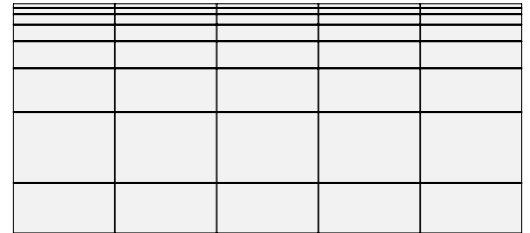

Layout 3

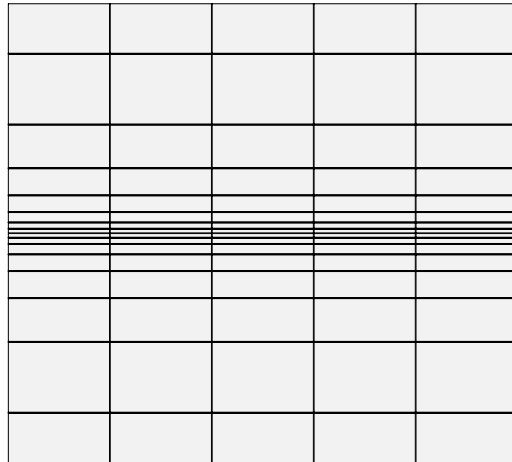

Layout 4

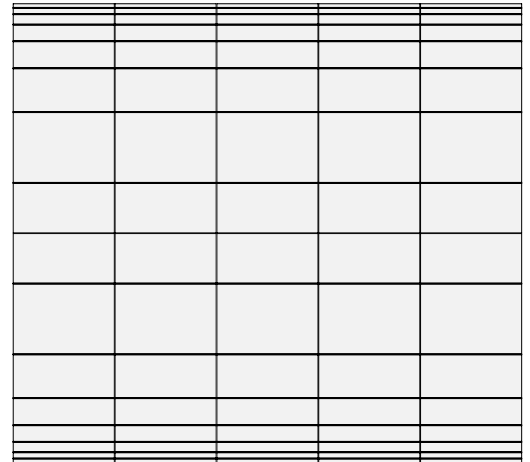

Recommended Layouts

Pipeline A

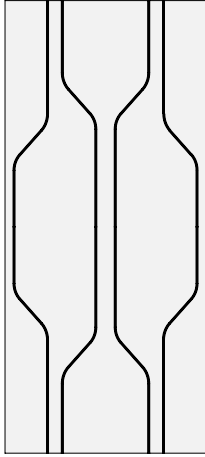

Layout 1

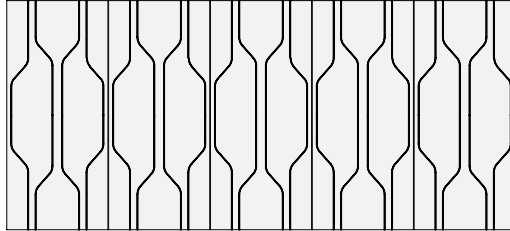

Layout 2

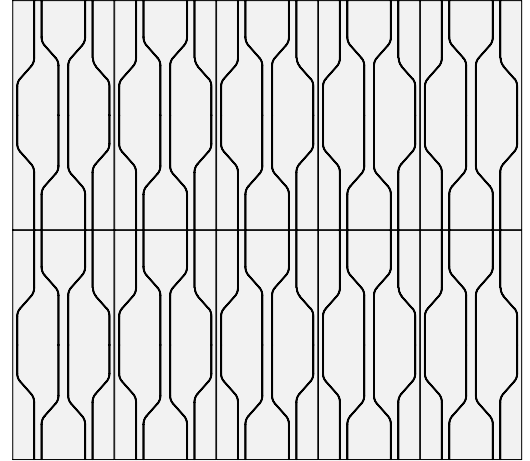

Pipeline B

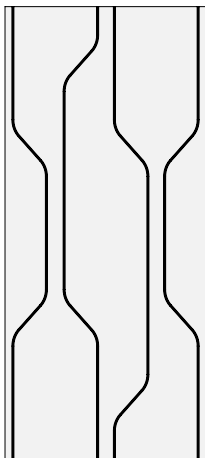

Layout 1

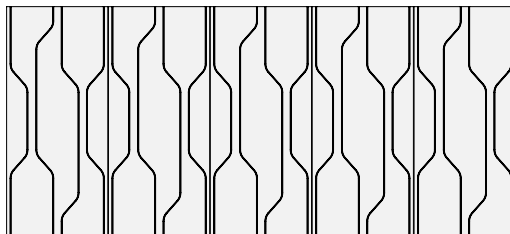

Layout 2

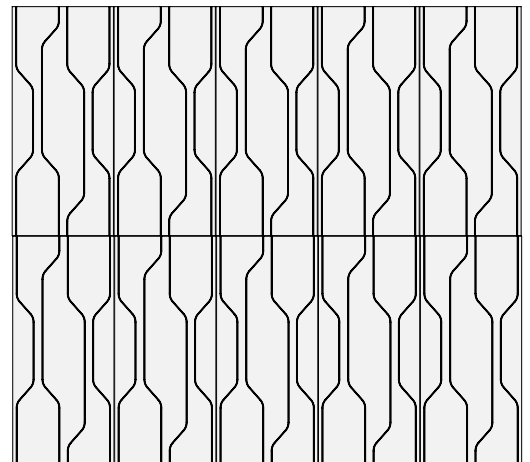

Recommended Layouts

Racetrack A

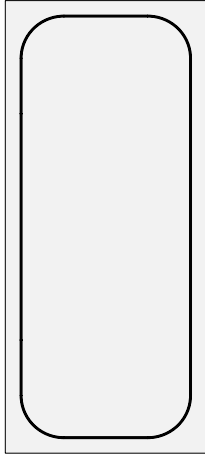

Layout 1

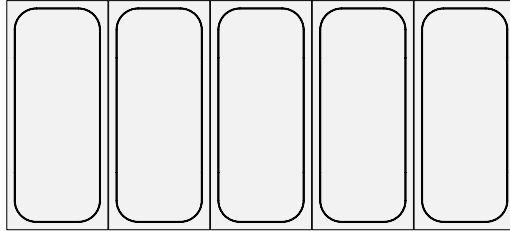

Layout 2

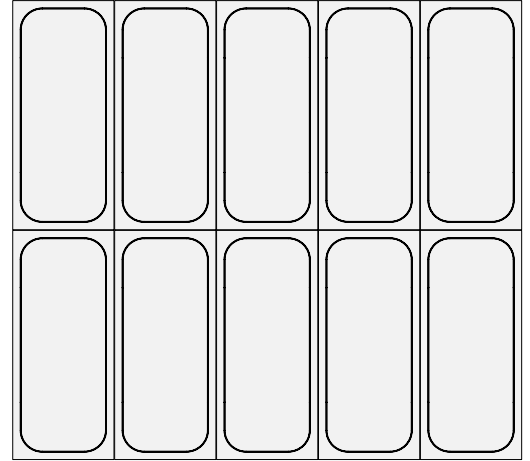

Racetrack B

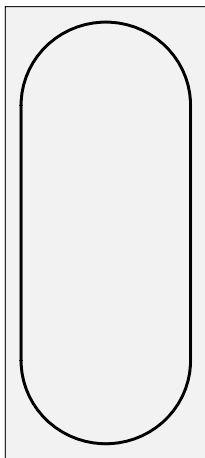

Layout 1

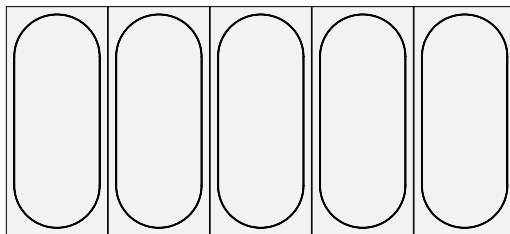

Layout 2

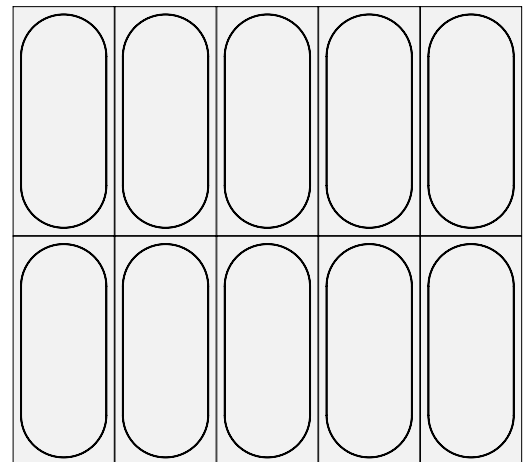

Recommended Layouts

Roundabout

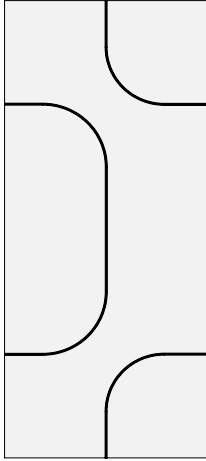

Layout 1

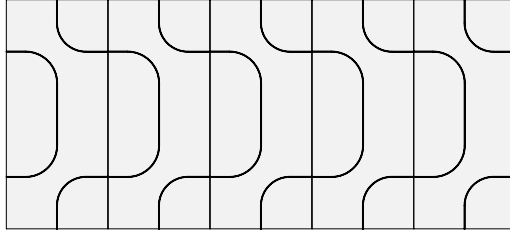

Layout 2

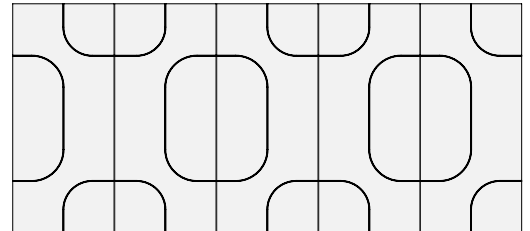

Layout 3

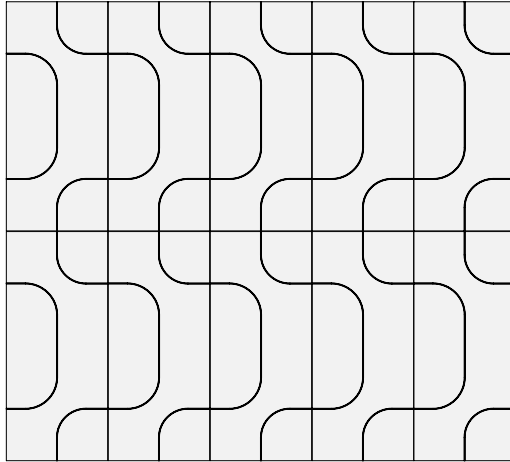

Layout 4

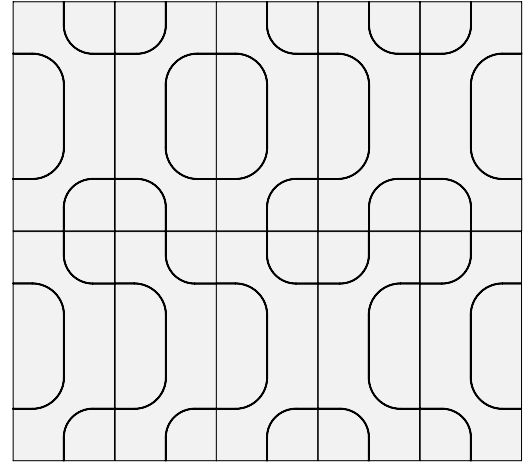

For questions or additional product information, visit [acoufelt.com](https://www.acoufelt.com) or call 800.966.8557.

Spine Wall Panels | January 2026

Recommended Layouts

Ruler

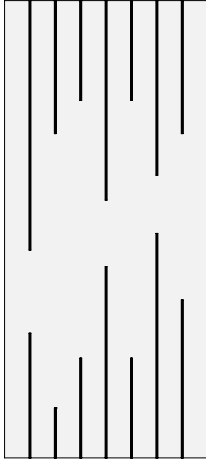

Layout 1

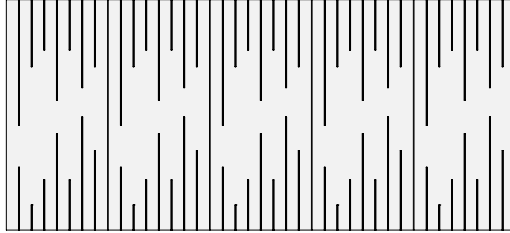

Layout 2

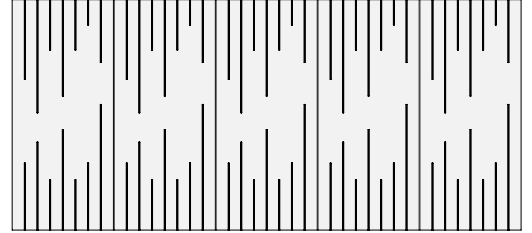

Layout 3

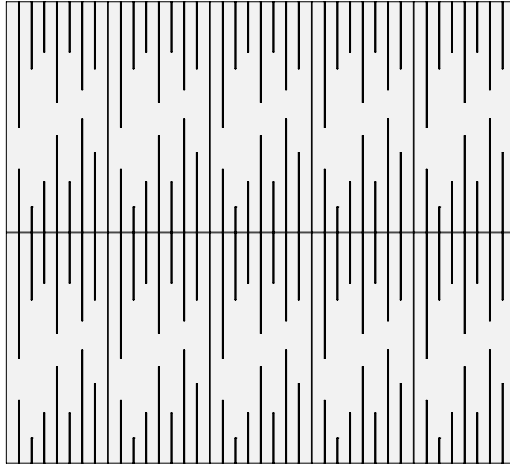

Layout 4

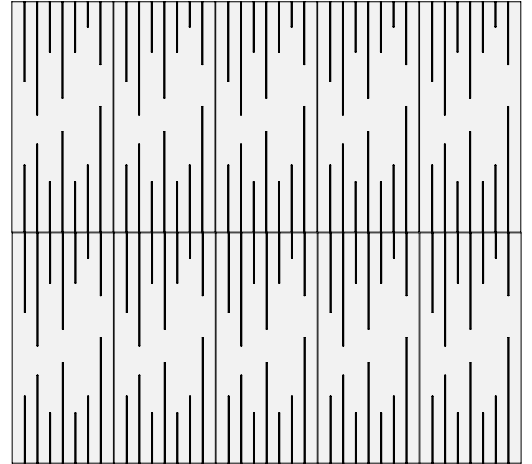

Recommended Layouts

Scored

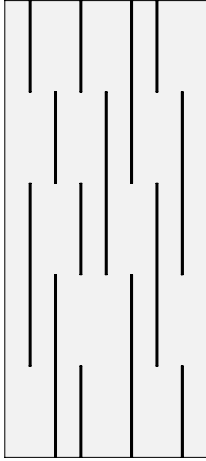

Layout 1

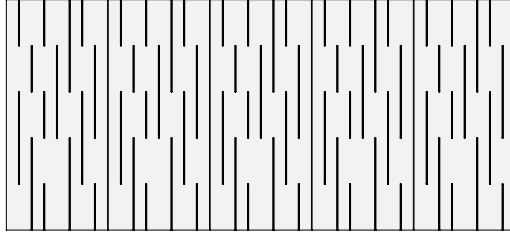

Layout 2

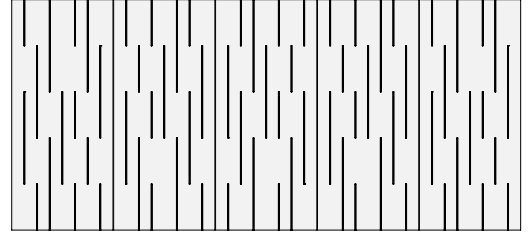

Layout 3

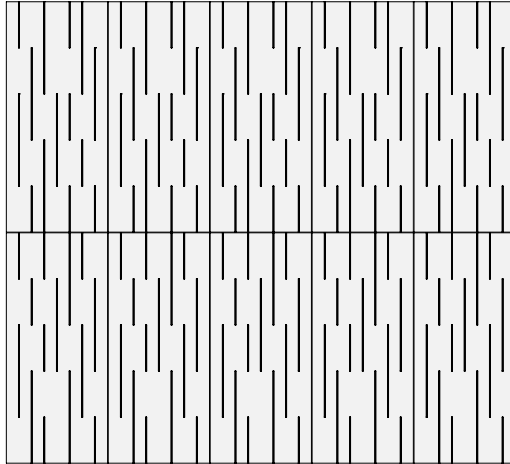

Layout 4

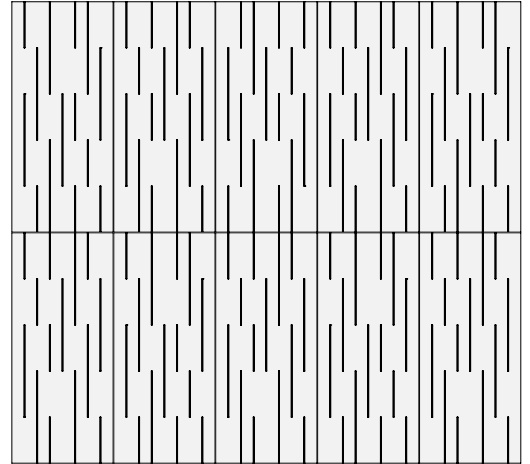

Recommended Layouts

Stems A

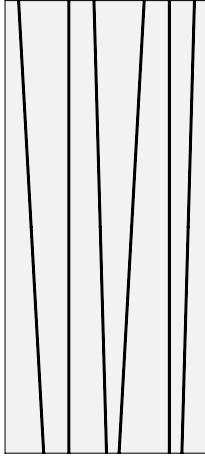

Layout 1

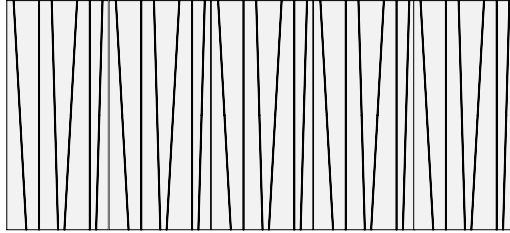

Stems B

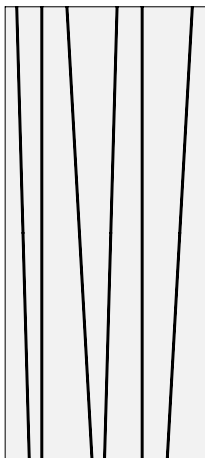

Layout 1

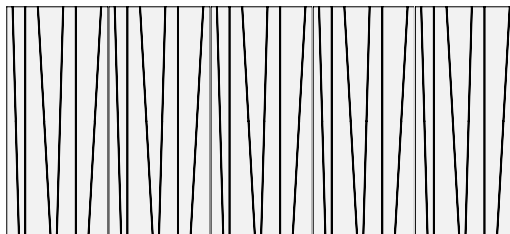

Layout 2

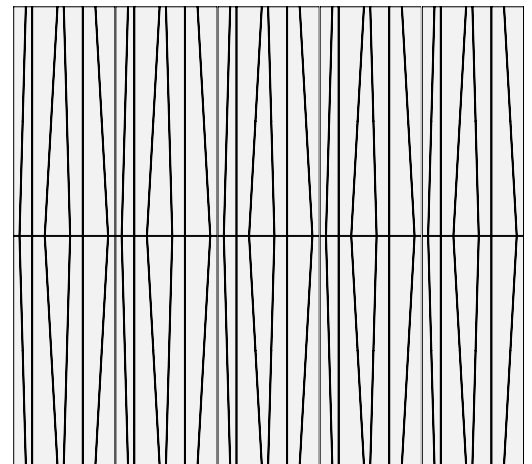

Recommended Layouts

Tulip A

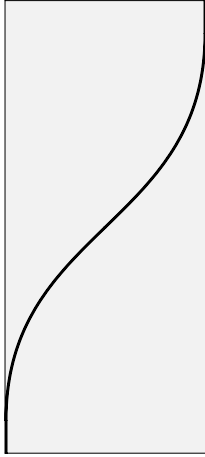

Layout 1

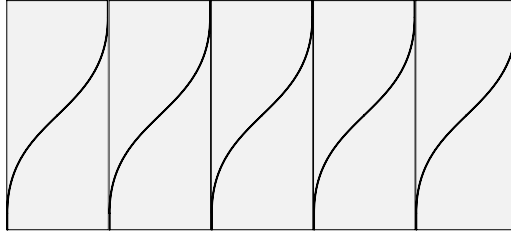

Layout 2 (50% Tulip A & 50% Tulip B)

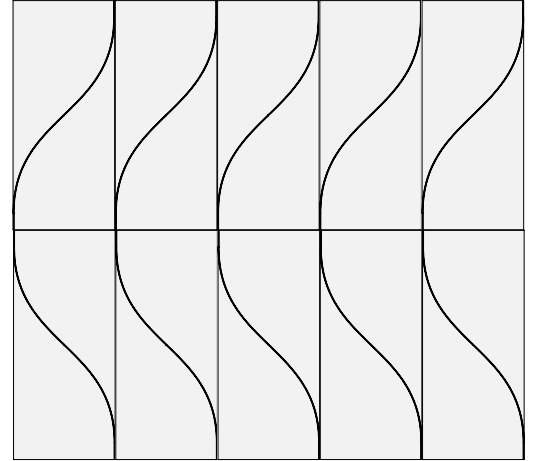

Tulip B



Layout 1

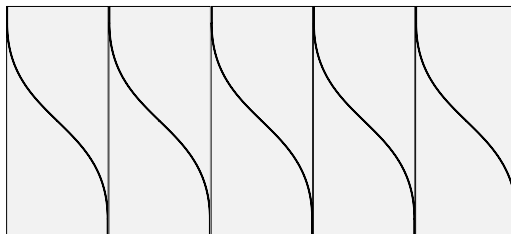

Layout 2 (50% Tulip A & 50% Tulip B)

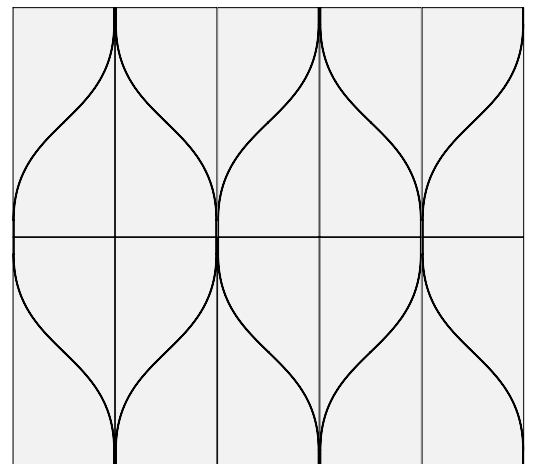

Mounting Methods

Adhesive backing

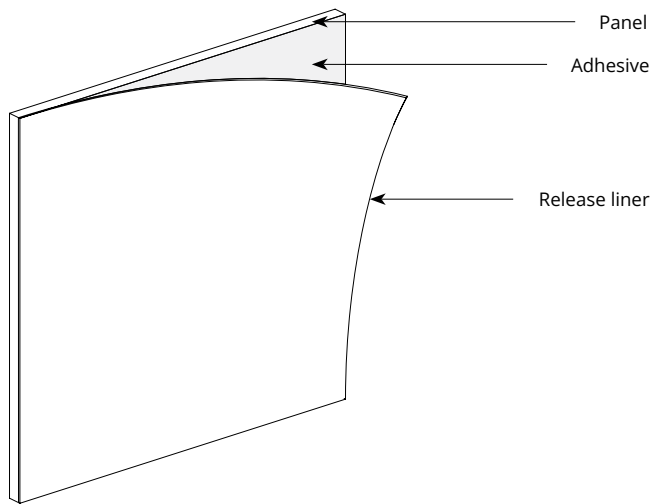

Construction adhesive

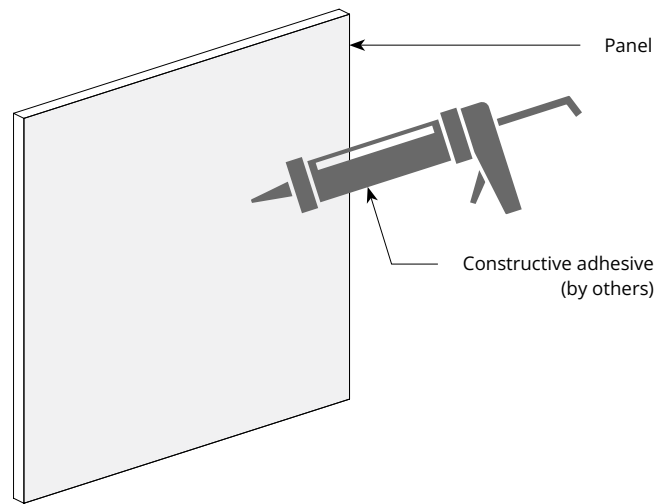

Z-clip wall mount

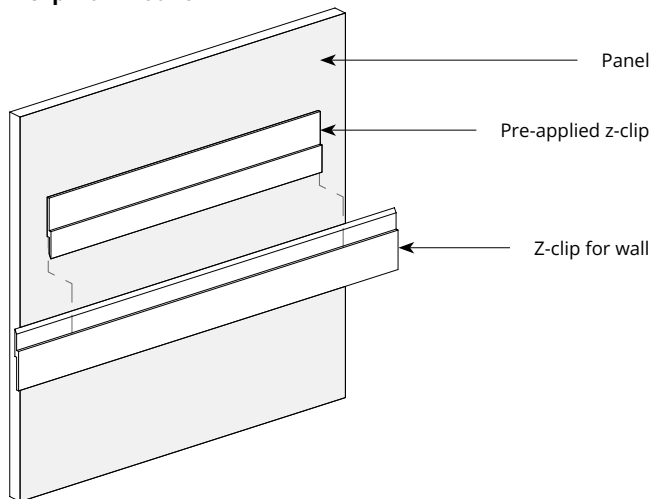

** For wall mount applications only.*

Acoustic Performance

Test Method	ASTM C423-09a
Install Method	A
Rating Method	ISO 11654-1997
Test Results	<p>12mm NRC 0.45, no air gap NRC 0.54, 12mm air gap NRC 0.64, 20mm air gap SAA 0.43, no air gap SAA 0.54, 12mm air gap</p> <p>24mm NRC 0.60, no air gap SAA 0.55, no air gap</p>

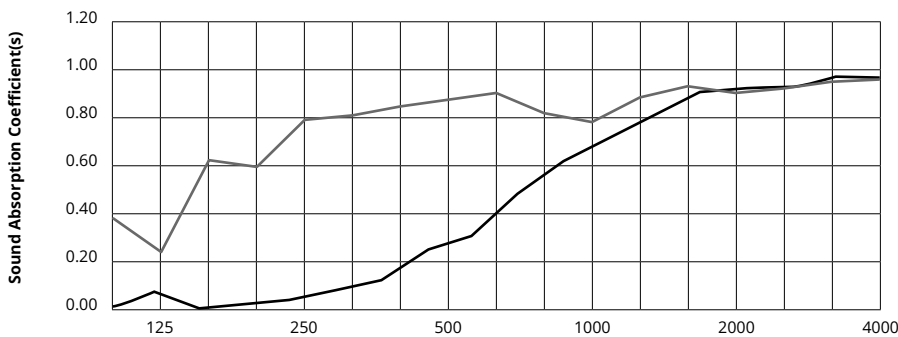

	Frequency f (Hz)	125	250	500	1000	2000	4000	NRC
	12mm	0.06	0.02	0.23	0.61	0.89	0.95	0.45
	24mm	0.02	0.57	0.41	0.58	0.87	0.85	0.60

What is a Noise Reduction Coefficient (NRC)?

You'll find the NRC rating in the specifications of all of our products. This acronym stands for Noise Reduction Coefficient, and is expressed as a single number, a rating that describes the degree to which acoustic products can absorb sound.

You can use NRC values to understand the overall performance of our acoustic wall and ceiling products. The higher the NRC, the better the product is at soaking up the sound.

Performance Indices: Noise Reduction Coefficient (NRC) results represent the absorption coefficients measured at the one third octave bands at 125, 250, 500, 1000, 2000 and 4000 Hz rounded to the nearest 0.05. Acoustic testing has been performed according to the methods mentioned above. Customization of installation of the product could alter the results. Sound Absorption Average (SAA) indicates the absorption coefficient average for the twelve one-third octave bands ranging between 200 and 2500 Hz.

 For questions or additional product information, visit [acoufelt.com](https://www.acoufelt.com) or call **800.966.8557**.

Spine Wall Panels | January 2026