

## Vista, Mountain Ceiling Frames

Premier Collection

Vista Mountain Ceiling Frames feature cubes with varying depths, creating a soothing, mountain-like design while providing exceptional sound management. Choose a single Premier color option or mix two complementary colors for the cubes and the backing. Modern, modular, and easy to install with T-grid clips, Vista transforms any busy environment into a more serene and visually striking space.

## Specifications

<b>Surface</b>	Ceiling	
<b>Material</b>	FilaSorb™ polyester felt	
<b>Weight</b>	0.49 lb./ft <sup>2</sup> (±10%)	
<b>Standard Sizes</b>	<b>Height</b>	<b>Backer Panels</b>
	3-6" H	24" W x 24" L
<b>Compatible T-grid</b>	<b>Type</b>	<b>Layout</b>
	15/16" Flat	Standard 24" x 24"
	9/16" Flat	Standard 24" x 24"

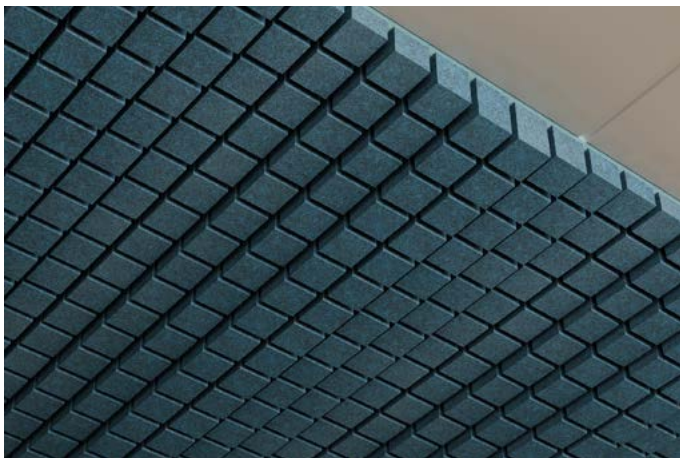

Vista, Mountain Ceiling Frames in Denim

## Technical

<b>NRC Rating</b>	1.30*
<b>Fire Test</b>	ASTM E84, Class A CAN/ULC-S102 Flame spread index: 15 Smoke developed index: 200
<b>Water Sorption</b>	ASTM C1104-2019 (A Modified) Water sorbed by weight: 0.20% (based on a 12mm thick panel)
<b>Colorfastness</b>	ISO 105-B02, 6-7

\* Rating is estimated based on similar product designs. Comparison NRC results available upon request.

## Details

<b>Lead Time</b>	3 - 6 weeks
<b>Origin</b>	Manufactured and assembled in the US
<b>Warranty</b>	Product: 20 years* Colorfastness: 20 years*

\* Conditions apply

## Environmental

<b>Recycled Content</b>	Minimum 60%
<b>Energy</b>	Generated using 40% solar energy
<b>Indoor Air Quality</b>	VOC less than/equal to 0.5mg/m3
<b>Recyclable</b>	100%*
<b>Certifications</b>	Declare Certification - LBC Red List Free (third-party verified) SCS Global Indoor Advantage Gold

\* PET is recyclable through participating partners



For questions or additional product information, visit [acoufelt.com](https://www.acoufelt.com) or call 800.966.8557.

Vista, Mountain Ceiling Frames | January 2026

# Colorways

## PREMIER



White  
WH12



Milkyway  
MI74



Ivory  
IV11



Pearl  
PE21



Valentine  
VA70



Quartz  
QU67



Stonewash  
ST72



Sea Salt  
SE57



Platinum  
PL04



Almond  
AL55



Pistachio  
PI25

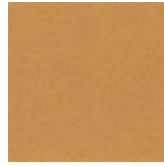

Turmeric  
TU60



Flamingo  
FL61



Amethyst  
AM69



Periwinkle  
PE23



Peacock  
PE20



Metal  
ME03



Mushroom  
MU75



Celery  
CE65



Wheat  
WH68



Peach  
PE19

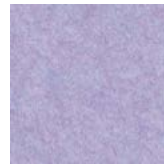

Lilac  
LI13



Marine  
MA15



Sencha  
SE58



Grey  
GR02



Umber  
UM54



Wasabi  
WA29

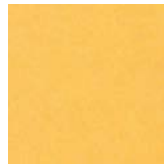

Popcorn  
PO26

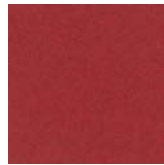

Currant  
CU59



Berry  
BE06



Azure  
AZ05



Oregano  
OR18



Charcoal  
CH01



Walnut  
WA56



Eucalyptus  
EU71

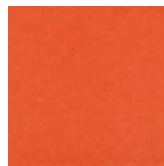

Carrot  
CA08

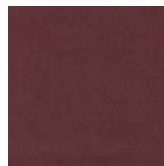

Loganberry  
LO77

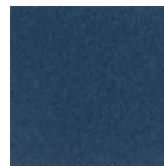

Granite  
GR62

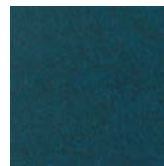

Denim  
DE09



Kale  
KA12

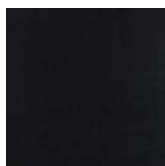

Piano Black  
PI24



Slate  
SL27



Nori  
NO76

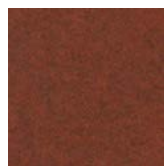

Peppercorn  
PE22

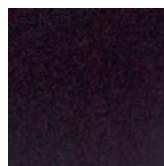

Shiraz  
SH63

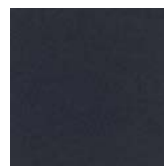

Flint  
FL64

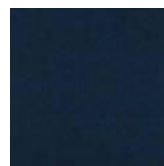

Midnight  
MI16

Order samples at [acoufelt.com/colorways](https://acoufelt.com/colorways)

 For questions or additional product information, visit [acoufelt.com](https://acoufelt.com) or call 800.966.8557.

Vista, Mountain Ceiling Frames | January 2026

# Sizes

**Standard Heights** 3-6" H (1" increments)

**Standard Widths** 24" W

**Standard Length** 24" L

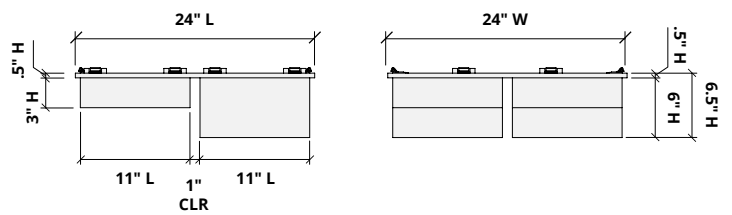
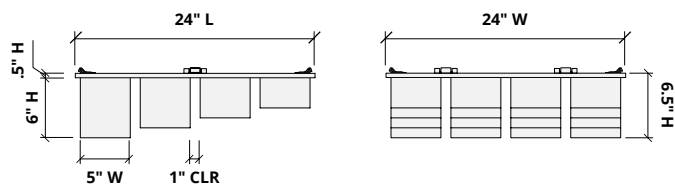
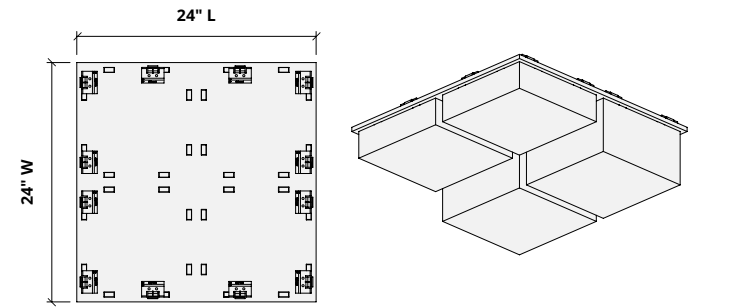
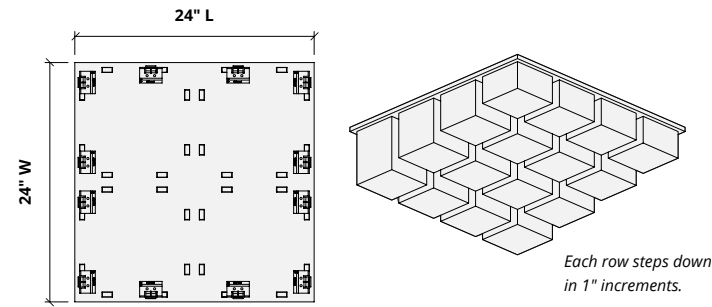

## Choose Colorways

Select one colorway for your cubes and one colorway for your backer panel; or one colorway for both. See colorway choices on page 3.

*If you're specifying dark colored backer panels, we recommend dark drop ceiling grids (not provided).*

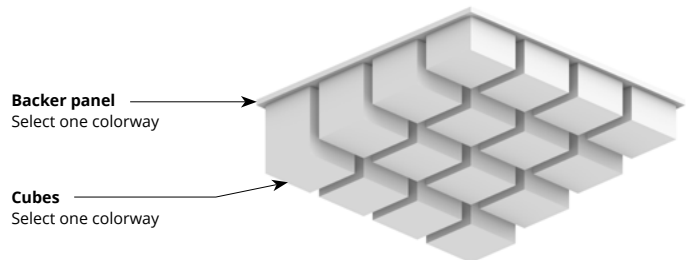

# Lighting Coordination

24" x 24", 24" x 48" Grid light

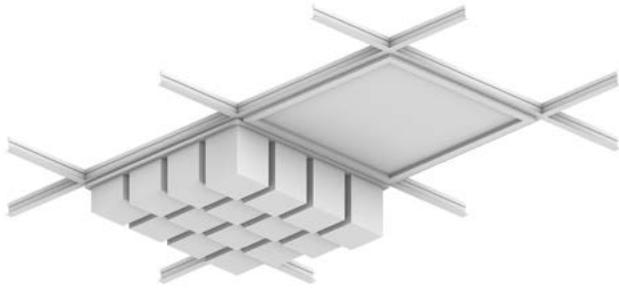

Drop pendant light

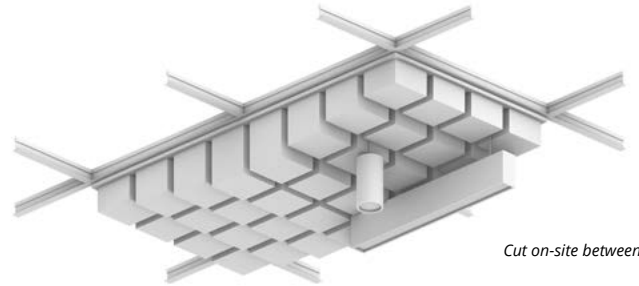

*Cut on-site between cubes*

Recessed light

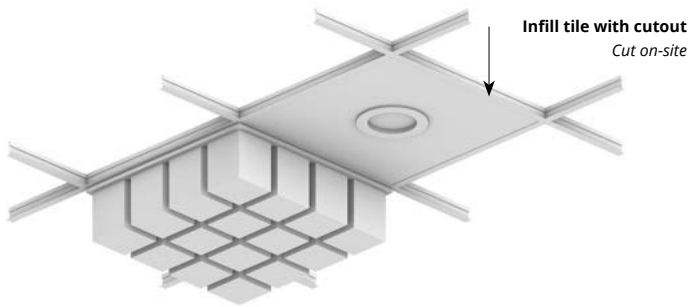

Grid mounted light (track, pendant)

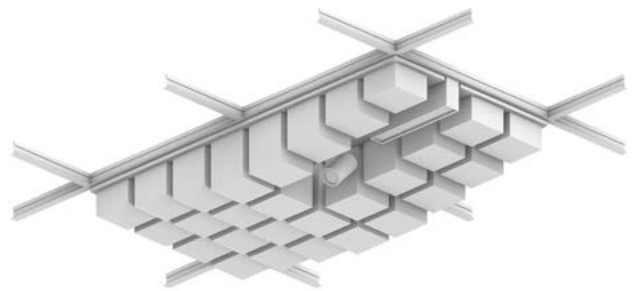

# Recommended Layout

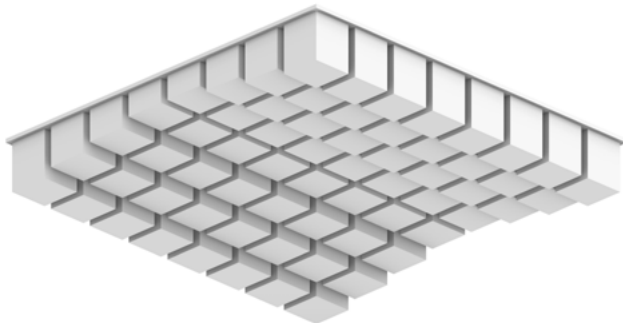

# Acoustic Performance

<b>Test Method</b>	ASTM C423-23
<b>Install Method</b>	
<b>Rating Method</b>	
<b>Mounting Method</b>	Type E-560
<b>Test Results</b>	NRC 1.30 SAA 1.30

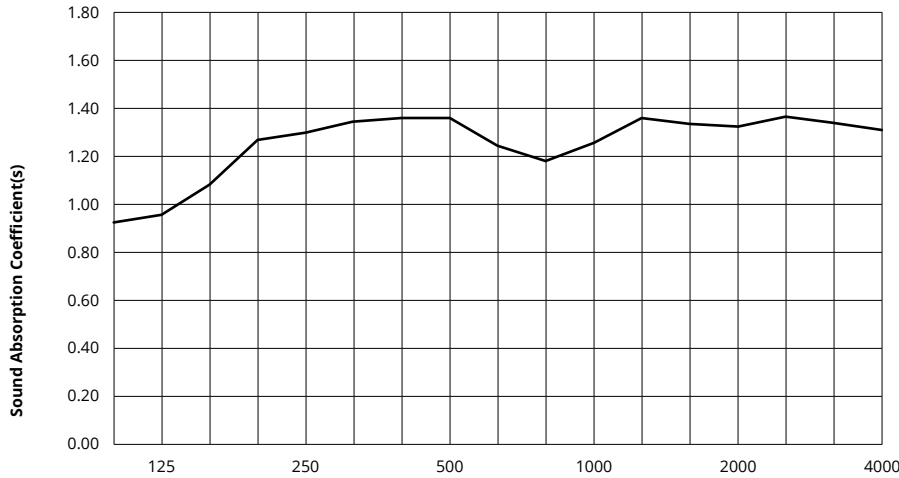

Frequency f (Hz)	125	250	500	1000	2000	4000	NRC
12mm	0.98	1.27	1.35	1.24	1.33	1.33	1.30

## What is a Noise Reduction Coefficient (NRC)?

You'll find the NRC rating in the specifications of all of our products. This acronym stands for Noise Reduction Coefficient, and is expressed as a single number, a rating that describes the degree to which acoustic products can absorb sound.

You can use NRC values to understand the overall performance of our acoustic wall and ceiling products. The higher the NRC, the better the product is at soaking up the sound.

*Performance Indices: Noise Reduction Coefficient (NRC) results represent the absorption coefficients measured at the one third octave bands at 125, 250, 500, 1000, 2000 and 4000 Hz rounded to the nearest 0.05. Acoustic testing has been performed according to the methods mentioned above. Customization of installation of the product could alter the results. Sound Absorption Average (SAA) indicates the absorption coefficient average for the twelve one-third octave bands ranging between 200 and 2500 Hz.*

 For questions or additional product information, visit [acoufelt.com](https://www.acoufelt.com) or call **800.966.8557**.

Vista, Mountain Ceiling Frames | January 2026