

Vista, Desert Ceiling Frames

WoodGrain Collection

Evenly arranged cubes of the Vista Desert design mimic a calming, open expanse of land while ensuring superior sound management. Choose a single Premier color or WoodGrain option or select two complementary finishes for the cubes and the backing. Modern, modular, and easy to install, Vista can change your outlook about working or meeting in a crowded space.

Specifications

Surface	Ceiling	
Material	FilaSorb™ polyester felt	
Weight	0.49 lb./ft ² (±10%)	
Standard Sizes	Height	3, 6" H
	Cube Sizes	5" W x 5" L 11" W x 11" L
	Backer Panels	24" W x 24" L
Compatible T-grid	Type	Layout
	15/16" Flat	Standard 24" x 24"
	9/16" Flat	Standard 24" x 24"

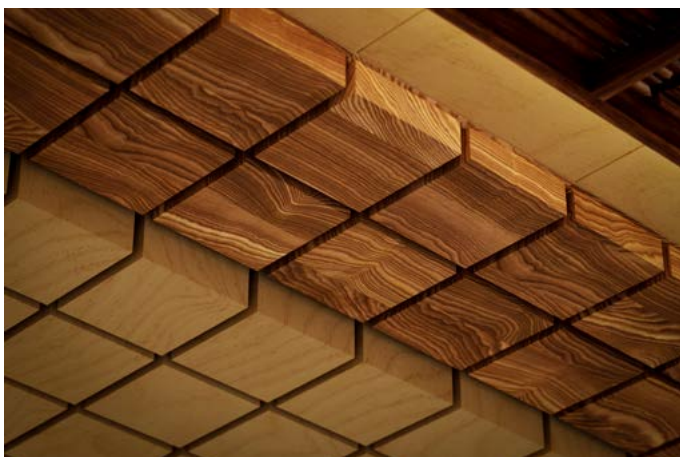

Vista, Desert Ceiling Frames in Baltic Birch and European Larch

Technical

NRC Rating	1.30*
Fire Test	ASTM E84, Class A CAN/ULC-S102 Flame spread index: 15 Smoke developed index: 200
Water Sorption	ASTM C1104-2019 (A Modified) Water sorbed by weight: 0.20% (based on a 12mm thick panel)
Colorfastness	ISO 105-B02, 6-7

* Rating is estimated based on similar product designs. Comparison NRC results available upon request.

Details

Lead Time	3 - 6 weeks
Origin	Manufactured and assembled in the US
Warranty	Product: 20 years* Colorfastness: 20 years*

* Conditions apply

Environmental

Recycled Content	Minimum 60%
Energy	Generated using 40% solar energy
Indoor Air Quality	VOC less than/equal to 0.5mg/m ³
Recyclable	100%*
Certifications	Declare Certification - LBC Red List Free (third-party verified) SCS Global Indoor Advantage Gold

* PET is recyclable through participating partners



For questions or additional product information, visit [acoufelt.com](https://www.acoufelt.com) or call **800.966.8557**.

Vista, Desert Ceiling Frames | January 2026

Colorways

WOODGRAIN



Picket Fence
WQ01



Loft
WQ06



White Elm
WQ07



Lyed Larch
WQ30



White Oak
WQ13



Baltic Birch
WQ12



Knotty Spruce
WQ29



French Bobbin
WQ08



Boat Shed
WQ02



Nordic Plank
WQ15



Boardwalk
WQ10



Mocha Legno
WQ25



Mountain Lodge
WQ24



Wine Barrel
WQ03



Log Cabin
WQ04



Natural Oak
WQ16



Woodland Fog
WQ22



Driftwood
WQ21



Weathered Slate
WQ14



Petrified Ash
WQ23



Antique Chest
WQ11



European Larch
WQ17



Fumed Oak
WQ19



Teak
WQ18



Charred Larch
WQ09



Shadow Oak
WQ28



Barn Door
WQ05



Black Walnut
WQ20



Scorched Timber
WQ26



Espresso Oak
WQ27

Order samples at acoufelt.com/colorways

Colorways

PREMIER



White
WH12



Milkyway
MI74



Ivory
IV11



Pearl
PE21



Valentine
VA70



Quartz
QU67



Stonewash
ST72



Sea Salt
SE57



Platinum
PL04



Almond
AL55



Pistachio
PI25



Turmeric
TU60



Flamingo
FL61



Amethyst
AM69



Periwinkle
PE23



Peacock
PE20



Metal
ME03



Mushroom
MU75



Celery
CE65



Wheat
WH68



Peach
PE19

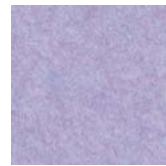

Lilac
LI13



Marine
MA15



Sencha
SE58



Grey
GR02

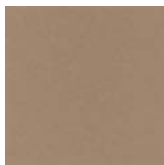

Umber
UM54

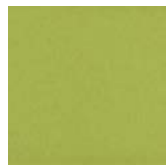

Wasabi
WA29

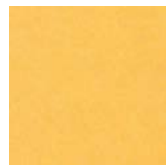

Popcorn
PO26

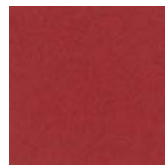

Currant
CU59

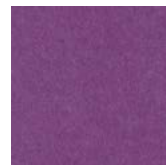

Berry
BE06

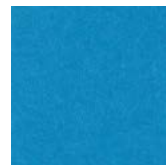

Azure
AZ05

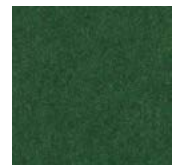

Oregano
OR18



Charcoal
CH01

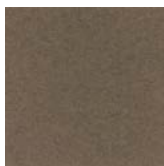

Walnut
WA56

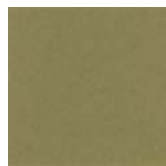

Eucalyptus
EU71

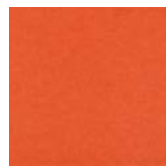

Carrot
CA08



Loganberry
LO77

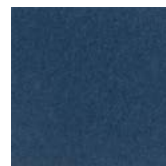

Granite
GR62



Denim
DE09

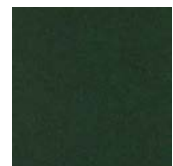

Kale
KA12



Piano Black
PI24

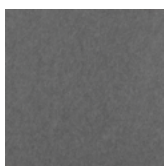

Slate
SL27

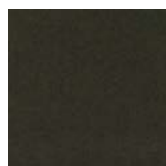

Nori
NO76

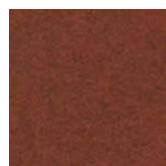

Peppercorn
PE22

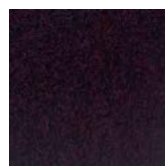

Shiraz
SH63

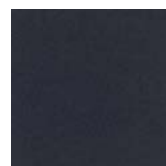

Flint
FL64

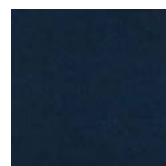

Midnight
MI16

Order samples at acoufelt.com/colorways



For questions or additional product information,
visit acoufelt.com or call 800.966.8557.

Vista, Desert Ceiling Frames | January 2026

Sizes

Standard Heights 3, 6" H

Standard Widths 24" W

Standard Length 24" L

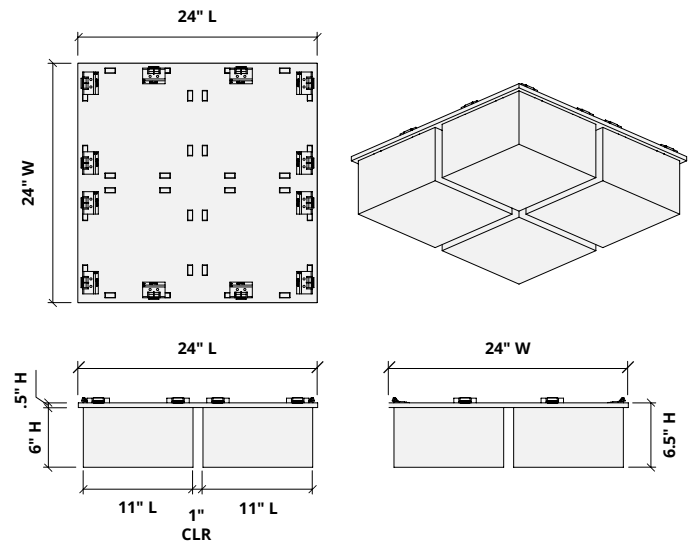
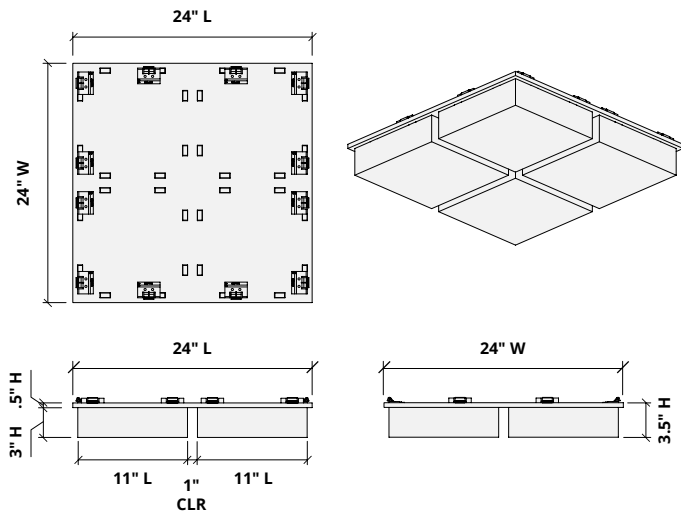
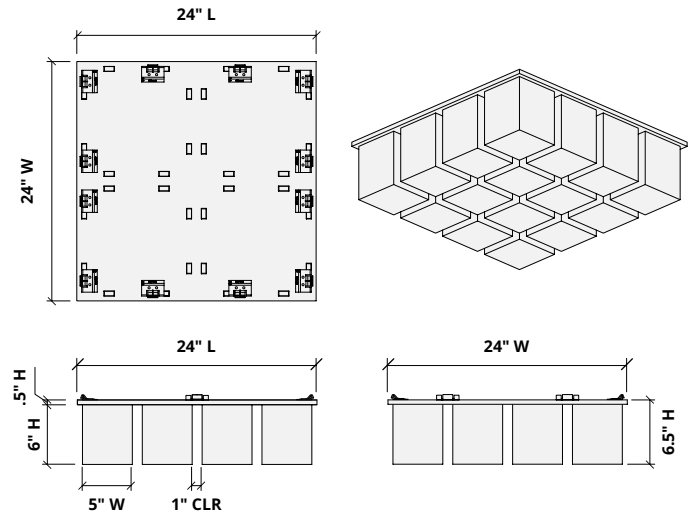
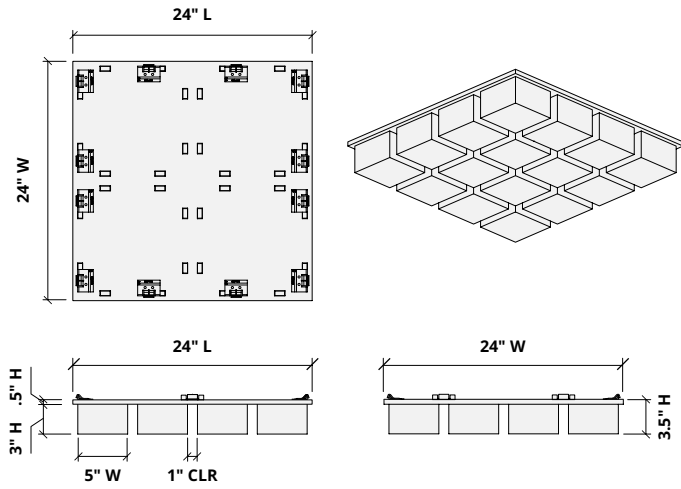

Choose Colorways

Select one colorway for your cubes and one colorway for your backer panel; or one colorway for both. See colorway choices on pages 3 and 4.

If you're specifying dark colored backer panels, we recommend dark drop ceiling grids (not provided).

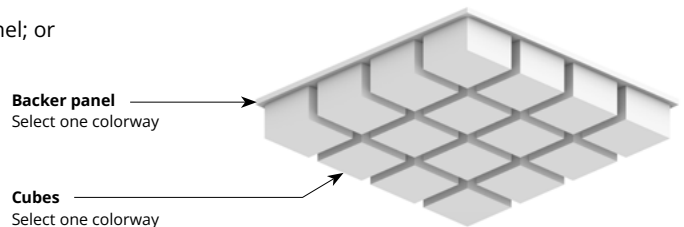

 For questions or additional product information, visit acoufelt.com or call 800.966.8557.

Vista, Desert Ceiling Frames | January 2026

Lighting Coordination

24" x 24", 24" x 48" Grid light

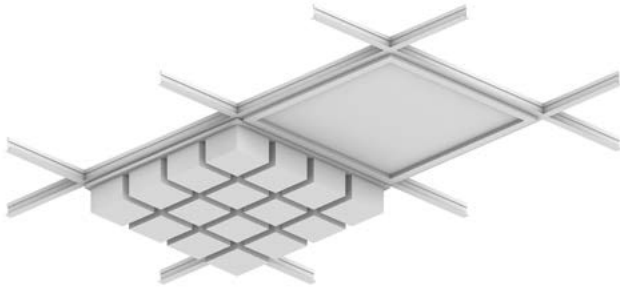

Drop pendant light

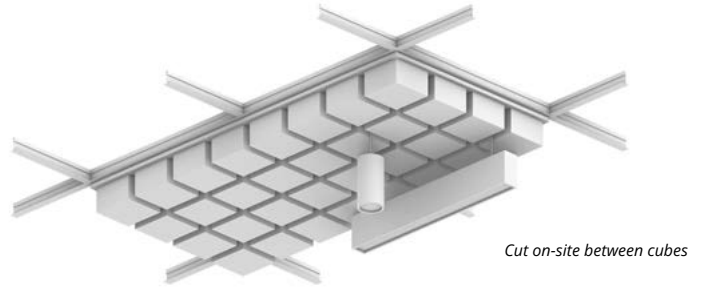

Recessed light

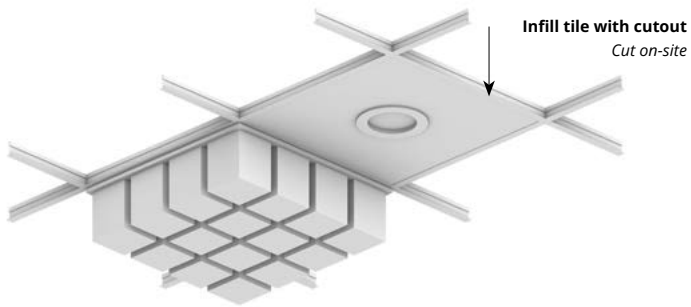

Grid mounted light (track, pendant)

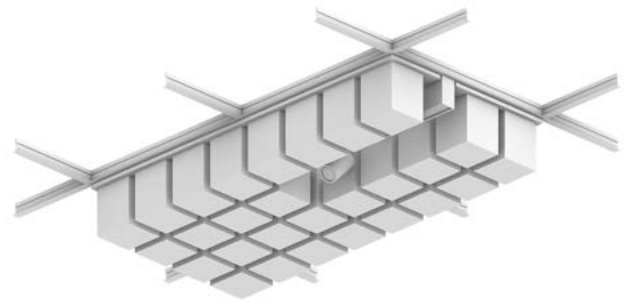

Recommended Layout

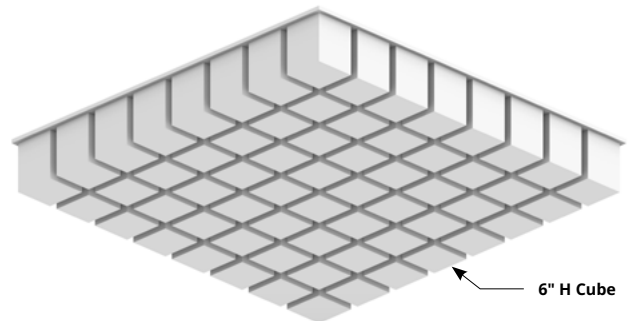
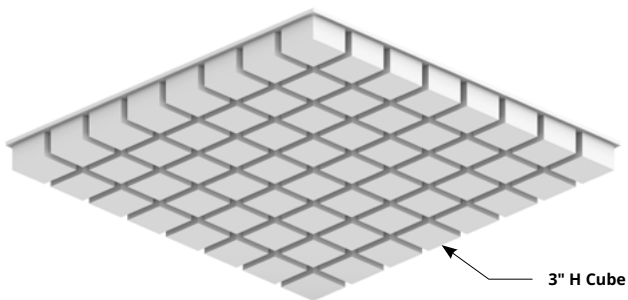

Acoustic Performance

Test Method	ASTM E795
Install Method	Type E-400
Rating Method	ASTM C423
Mounting Method	2" W x 3" H slat on 12mm backer with 400mm air gap
Test Results	NRC 0.95 SAA 0.96

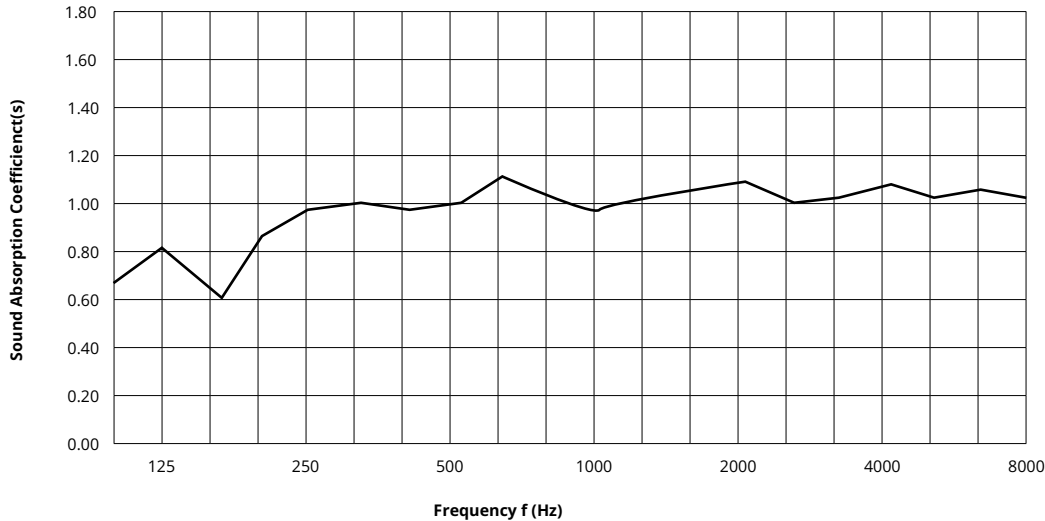

Frequency f (Hz)	125	250	500	1000	2000	4000	NRC
12mm	0.67	0.86	0.96	1.02	1.04	1.00	0.95

What is a Noise Reduction Coefficient (NRC)?

You'll find the NRC rating in the specifications of all of our products. This acronym stands for Noise Reduction Coefficient, and is expressed as a single number, a rating that describes the degree to which acoustic products can absorb sound.

You can use NRC values to understand the overall performance of our acoustic wall and ceiling products. The higher the NRC, the better the product is at soaking up the sound.

Performance Indices: Noise Reduction Coefficient (NRC) results represent the absorption coefficients measured at the one third octave bands at 125, 250, 500, 1000, 2000 and 4000 Hz rounded to the nearest 0.05. Acoustic testing has been performed according to the methods mentioned above. Customization of installation of the product could alter the results. Sound Absorption Average (SAA) indicates the absorption coefficient average for the twelve one-third octave bands ranging between 200 and 2500 Hz.

 For questions or additional product information, visit [acoufelt.com](https://www.acoufelt.com) or call **800.966.8557**.

Vista, Desert Ceiling Frames | January 2026