

## Rail, Route Ceiling Frames

Premier Collection

Rail Ceiling Frames offer unmatched flexibility to craft unique, textured ceilings. With an open-tile design and the absence of a backer, Rail seamlessly integrates with essential ceiling components like lighting, sprinklers, and speakers.

The Rail frames system ensures hassle-free installation with its innovative click-in design, eliminating the need for additional hardware. Fully compatible with standard 15/16" T-grid drop ceilings, it provides a versatile and efficient solution for modern ceiling designs.

## Specifications

<b>Surface</b>	Ceiling	
<b>Material</b>	FilaSorb™ polyester felt	
<b>Weight</b>	0.49 lb./ft <sup>2</sup> (±10%) 0.98 lb./ft <sup>2</sup> (±10%)	
<b>Standard Sizes</b>	24" W x 24" L x 4" H 24" W x 24" L x 6" H 24" W x 48" L x 4" H 24" W x 48" L x 6" H	
<b>Compatible T-grid</b>	<b>Type</b>	<b>Layout</b>
	15/16" Flat	Standard 24" x 24"
	9/16" Flat	Standard 24" x 24"

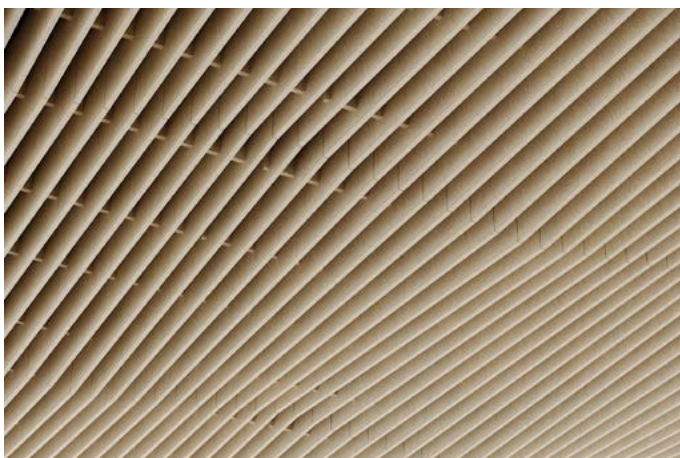

Rail, Route Ceiling Frames in Pearl

## Technical

<b>NRC Rating</b>	Pending product testing
<b>Fire Test</b>	ASTM E84, Class A Flame spread index: 15 Smoke developed index: 200
<b>Water Sorption</b>	ASTM C1104-2019 (A Modified) Water sorbed by weight: 0.20% (based on a 12mm thick panel)
<b>Colorfastness</b>	ISO 105-B02, 6-7

## Details

<b>Lead Time</b>	3 – 6 weeks
<b>Origin</b>	Manufactured and assembled in the US
<b>Warranty</b>	Product: 20 years* Colorfastness: 20 years*

\* Conditions apply

## Environmental

<b>Recycled Content</b>	Minimum 60%
<b>Energy</b>	Generated using 40% solar energy
<b>Indoor Air Quality</b>	VOC less than/equal to 0.5mg/m3
<b>Recyclable</b>	100%*
<b>Certifications</b>	Declare Certification - LBC Red List Free (third-party verified) SCS Global Indoor Advantage Gold

\* PET is recyclable through participating partners



For questions or additional product information, visit [acoufelt.com](https://www.acoufelt.com) or call 800.966.8557.

Rail, Route Ceiling Frames | February 2026

# Colorways

## PREMIER

							
White WH12	Milkyway MI74	Ivory IV11	Pearl PE21	Valentine VA70	Quartz QU67	Stonewash ST72	Sea Salt SE57
							
Platinum PL04	Almond AL55	Pistachio PI25	Turmeric TU60	Flamingo FL61	Amethyst AM69	Periwinkle PE23	Peacock PE20
							
Metal ME03	Mushroom MU75	Celery CE65	Wheat WH68	Peach PE19	Lilac LI13	Marine MA15	Sencha SE58
							
Grey GR02	Umber UM54	Wasabi WA29	Popcorn PO26	Currant CU59	Berry BE06	Azure AZ05	Oregano OR18
							
Charcoal CH01	Walnut WA56	Eucalyptus EU71	Carrot CA08	Loganberry LO77	Granite GR62	Denim DE09	Kale KA12
							
Piano Black PI24	Slate SL27	Nori NO76	Peppercorn PE22	Shiraz SH63	Flint FL64	Midnight MI16	

Order samples at [acoufelt.com/colorways](https://acoufelt.com/colorways)

 For questions or additional product information, visit [acoufelt.com](https://acoufelt.com) or call 800.966.8557.

Rail, Route Ceiling Frames | February 2026

# How to Specify

1. Choose Slat Height

2. Choose Tile Size

3. Choose Colorway

Slats are available in two overall heights:

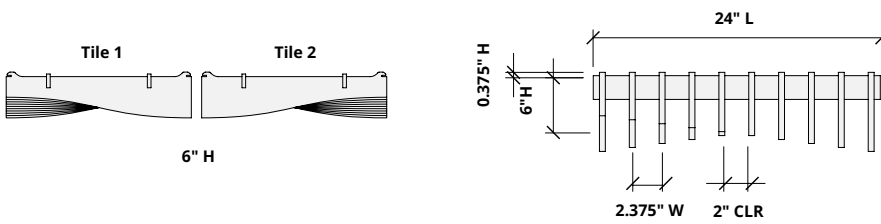
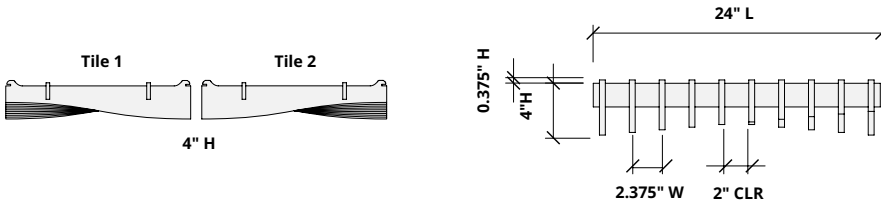

1. Choose Slat Height

2. Choose Tile Size

3. Choose Colorway

Ties are available in two sizes for use with 4" H and 6" H slats.

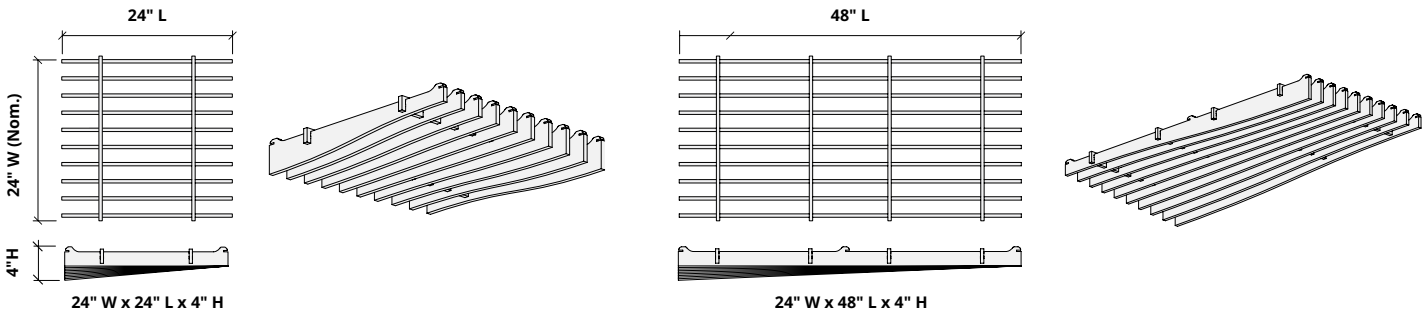

1. Choose Slat Height

2. Choose Tile Size

3. Choose Colorway

Select one colorway for your tile. See colorway choices on page 3.

# Recommended Layouts

## Layout 1

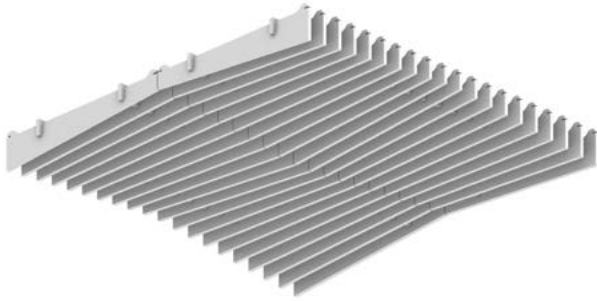

# Lighting Coordination

## 2' x 2', 2' x 4' Grid light

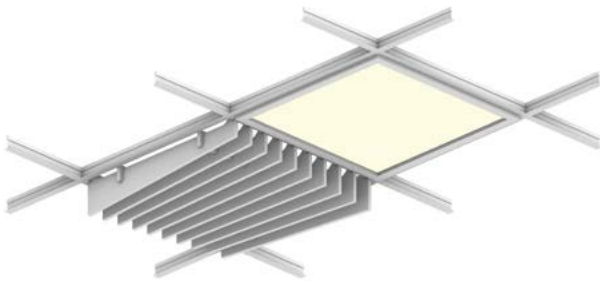

## Drop pendant light

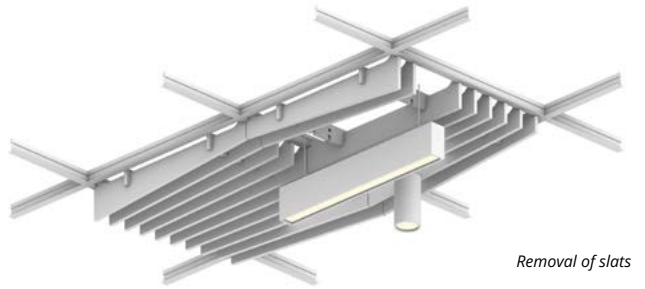

## Recessed light

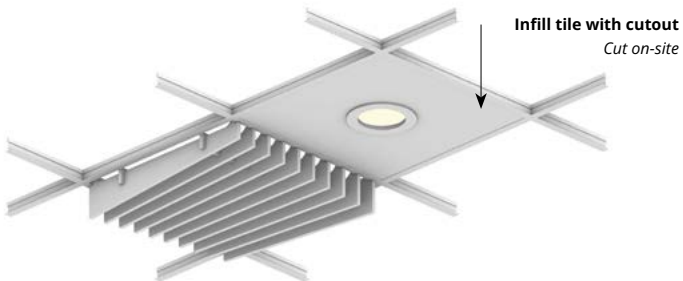

## Grid mounted light (track, pendant)

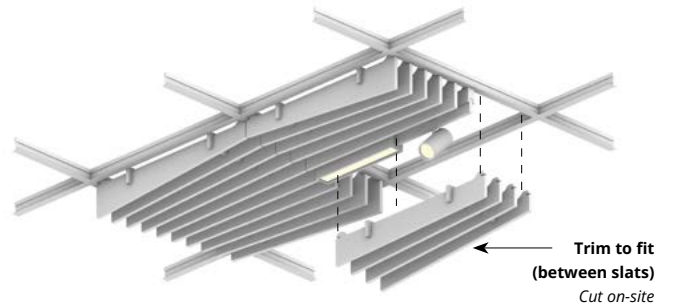

# Acoustic Performance

<b>Test Method</b>	ASTM E795
<b>Install Method</b>	E-400
<b>Rating Method</b>	ASTM C423-17
<b>Mounting Method</b>	
<b>Test Results</b>	Pending product testing

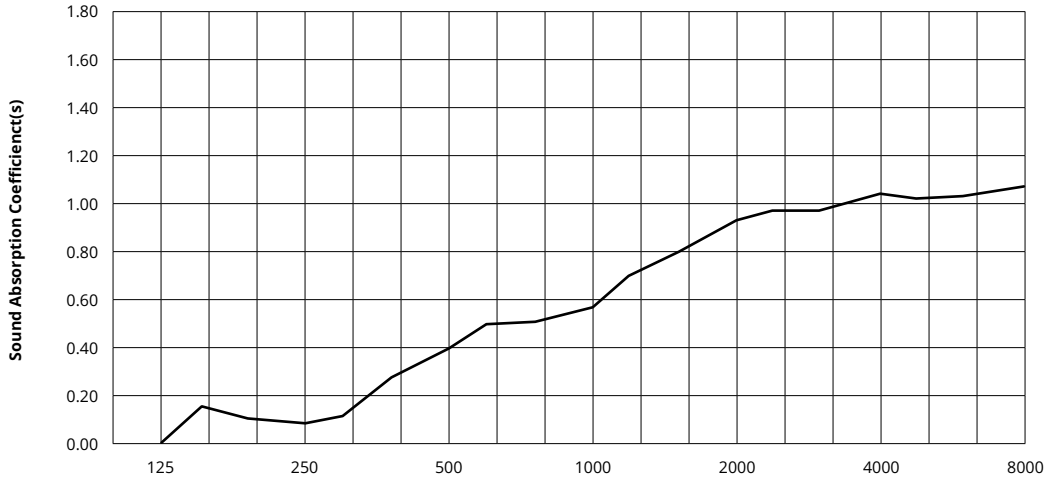

Frequency f (Hz)	125	250	500	1000	2000	4000	8000	NRC
12mm	Pending product testing							

## What is a Noise Reduction Coefficient (NRC)?

You'll find the NRC rating in the specifications of all of our products. This acronym stands for Noise Reduction Coefficient, and is expressed as a single number, a rating that describes the degree to which acoustic products can absorb sound.

You can use NRC values to understand the overall performance of our acoustic wall and ceiling products. The higher the NRC, the better the product is at soaking up the sound.

*Performance Indices: Noise Reduction Coefficient (NRC) results represent the absorption coefficients measured at the one third octave bands at 125, 250, 500, 1000, 2000 and 4000 Hz rounded to the nearest 0.05. Acoustic testing has been performed according to the methods mentioned above. Customization of installation of the product could alter the results. Sound Absorption Average (SAA) indicates the absorption coefficient average for the twelve one-third octave bands ranging between 200 and 2500 Hz.*

 For questions or additional product information, visit [acoufelt.com](http://acoufelt.com) or call **800.966.8557**.

**Rail, Route Ceiling Frames** | February 2026