



Blox, Deep Ceiling Clouds

WoodGrain Collection

Pacify problematic sound by beautifully boxing up the racket. With a deeper-set insert to add greater contrast and drama, Blox ceiling clouds offer a fresh take on noise reduction while inviting you to customize your space with Premier colors from subtle to bold shades, realistic WoodGrain patterns, or a combination inside and out. Blox allows total creativity to blend sizes, play with color, and add lighting as you like.

Specifications

Surface	Ceiling
Material	FilaSorb™ polyester felt
Weight	0.49 lb./ft ² (±10%)
Standard Sizes	Width: 20" up to 44" W (2" increments) Length: 20" up to 44" L (2" increments) Height: 10" up to 20" H (2" increments)



Blox, Deep Ceiling Cloud in Driftwood

Technical

NRC Rating	Pending product testing
Fire Test	ASTM E84, Class A CAN/ULC-S102 Flame spread index: 15 Smoke developed index: 200
Water Sorption	ASTM C1104-2019 (A Modified) Water sorbed by weight: 0.20% (based on a 12mm thick panel)
Colorfastness	ISO 105-B02, 6-7

Details

Lead Time	3 – 6 weeks
Origin	Manufactured and assembled in the US
Warranty	Product: 20 years* Colorfastness: 20 years*

* Conditions apply

Environmental

Recycled Content	Minimum 60%
Energy	Generated using 40% solar energy
Indoor Air Quality	VOC less than/equal to 0.5mg/m ³
Recyclable	100%*
Certifications	Declare Certification - LBC Red List Free (third-party verified) SCS Global Indoor Advantage Gold

* PET is recyclable through participating partners.



For questions or additional product information, visit [acoufelt.com](https://www.acoufelt.com) or call 800.966.8557.

Blox, Deep Ceiling Clouds | December 2025

Colorways

WOODGRAIN



Picket Fence
WQ01



Loft
WQ06



White Elm
WQ07



Lyed Larch
WQ30



White Oak
WQ13



Baltic Birch
WQ12



Knotty Spruce
WQ29



French Bobbin
WQ08



Boat Shed
WQ02



Nordic Plank
WQ15



Boardwalk
WQ10



Mocha Legno
WQ25

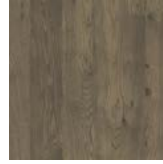

Mountain Lodge
WQ24



Wine Barrel
WQ03



Log Cabin
WQ04



Natural Oak
WQ16



Woodland Fog
WQ22



Driftwood
WQ21



Weathered Slate
WQ14



Petrified Ash
WQ23

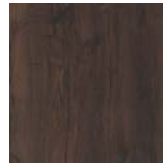

Antique Chest
WQ11



European Larch
WQ17



Fumed Oak
WQ19



Teak
WQ18



Charred Larch
WQ09



Shadow Oak
WQ28



Barn Door
WQ05



Black Walnut
WQ20



Scorched Timber
WQ26



Espresso Oak
WQ27

Order samples at acoufelt.com/colorways

Sizes

Standard Width: 20" up to 44" W (2" increments)

Standard Height: 10" up to 20" H (2" increments)

Standard Length: 20" up to 44" L (2" increments)

Plan

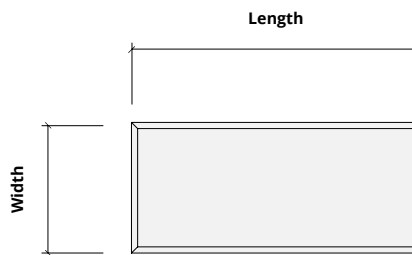
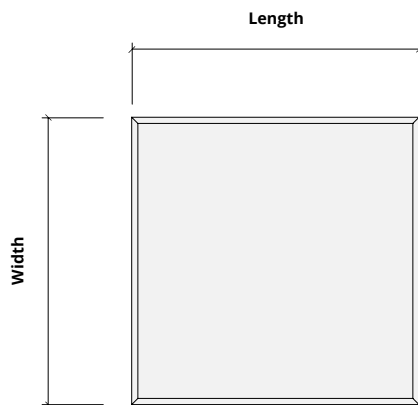

Elevations

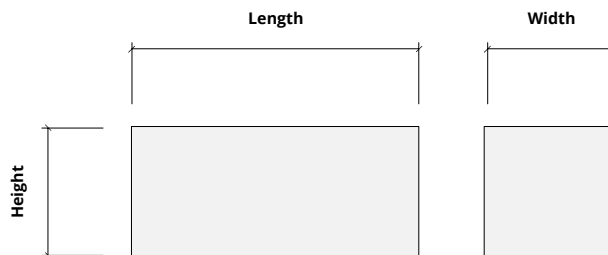
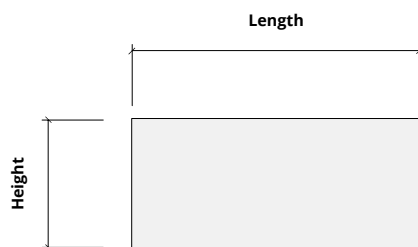

Perspective

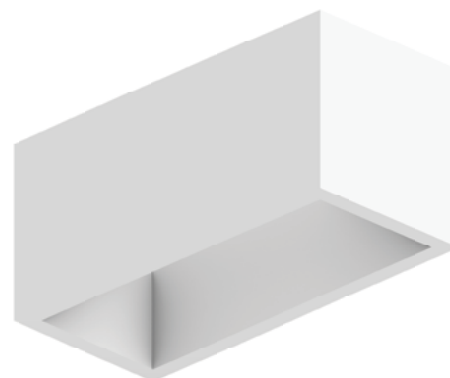
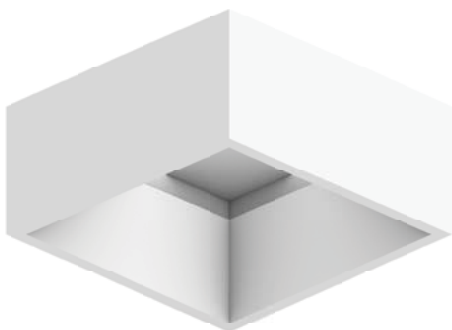

Hardware Spacing

20, 22, 24, 26, 28, 30" W	12" on center spacing
32, 34, 36, 38, 40, 42, 44, 48" W	24" on center spacing

20, 22, 24, 26, 28, 30" L	12" on center spacing
32, 34, 36, 38, 40, 42, 44" L	24" on center spacing

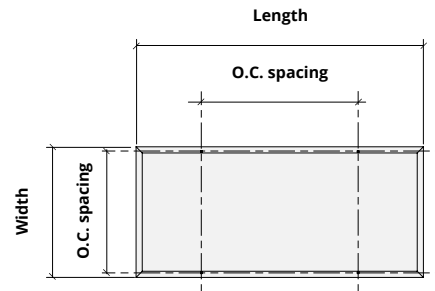
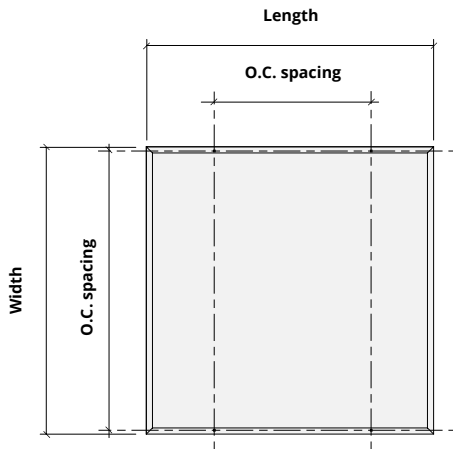

How to Specify

1. Choose Sizes

2. Choose Colorways

3. Optional Lighting

Blox sizes and shapes can be mixed to create the desired design. See Blox, Angled and Shallow specification sheets for additional information.

1. Choose Sizes

2. Choose Colorways

3. Optional Lighting

Select one or multiple colorways to achieve the overall desired design. See colorway choices on page 3.

1. Choose Sizes

2. Choose Colorways

3. Optional Lighting

Select lighting if desired. See enclosed lighting information sheets for additional information.

Mounting Methods

Cable to deck

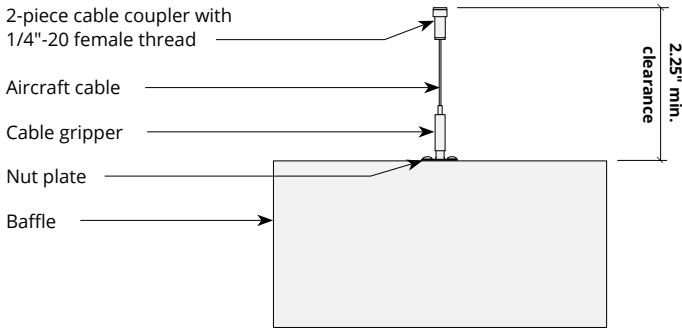

Hardware Kits:
 HK1006 - 48" Cable
 HK1010 - 120" Cable

Swivel cable to deck

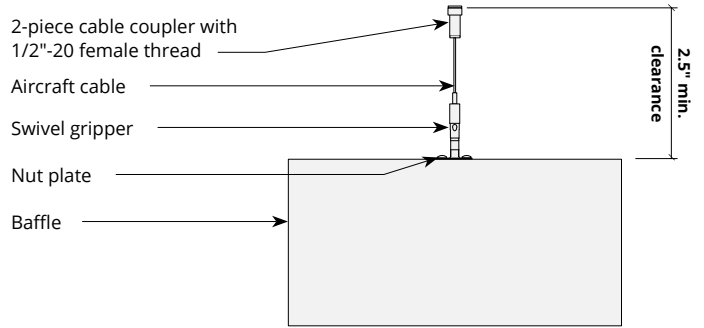

Hardware Kits:
 HK1007 - 48" Cable
 HK1011 - 120" Cable

Cable to strut channel

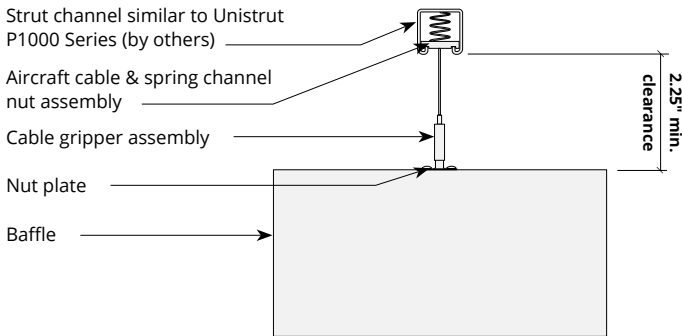

Hardware Kits:
 HK1009 - 48" Cable
 HK1013 - 120" Cable

Threaded rod

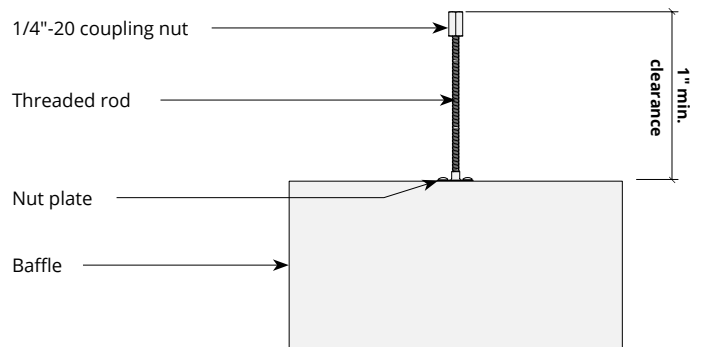

Hardware Kits:
 HK1014 - 24" Cable
 HK1015 - 48" Cable

Threaded rod to strut channel

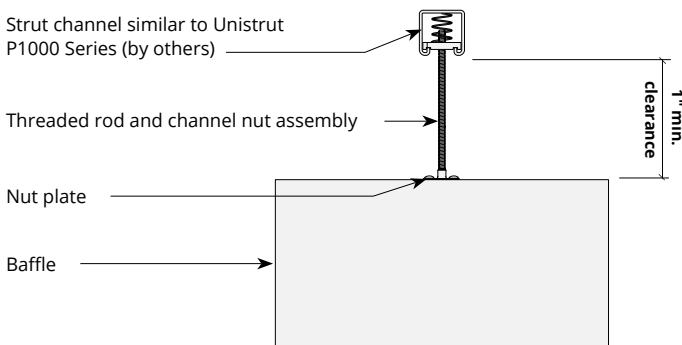

Hardware Kits:
 HK1277 - 24" Cable
 HK1278 - 48" Cable

Direct to strut channel

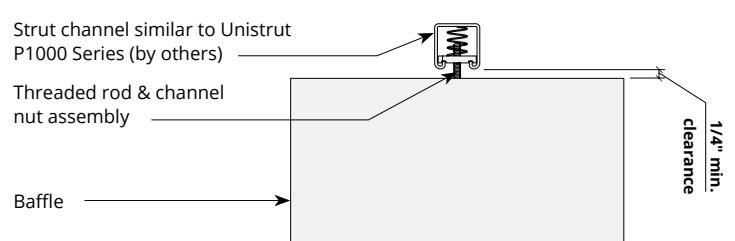

Hardware Kits:
 HK1016

Acoustic Performance

Test Method	ASTM E795-16
Install Method	J-600
Rating Method	ASTM C423-17
Mounting Method	Sample tested 5 baffles 110" L x 12" D x 3" thickness, hanging 600mm from floor and 152mm from each other
Test Results	Pending product testing

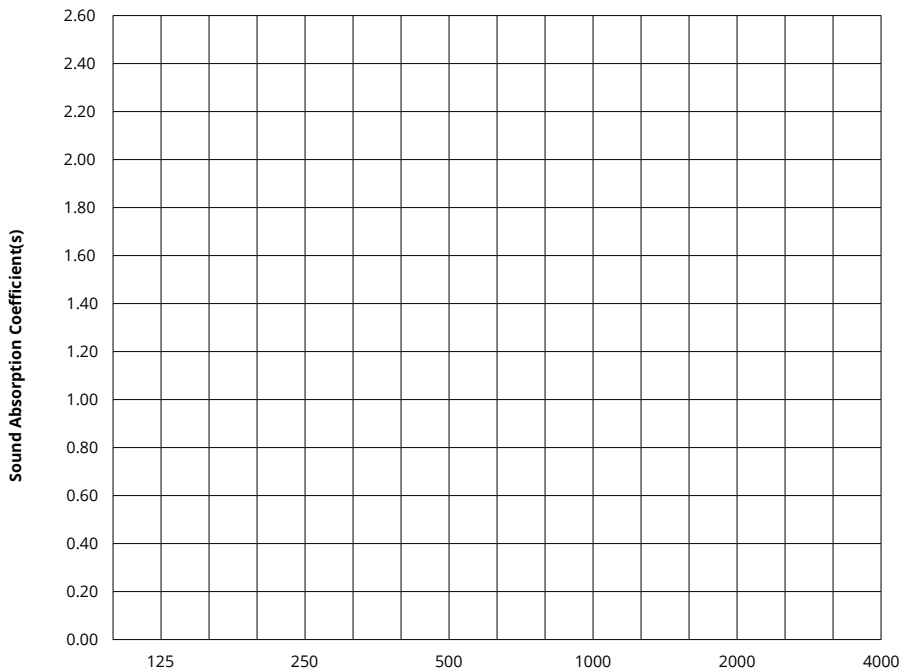

Frequency f (Hz)	125	250	500	1000	2000	4000	NRC
3" Truss Baffle	Pending product testing						

What is a Noise Reduction Coefficient (NRC)?

You'll find the NRC rating in the specifications of all of our products. This acronym stands for Noise Reduction Coefficient, and is expressed as a single number, a rating that describes the degree to which acoustic products can absorb sound.

You can use NRC values to understand the overall performance of our acoustic wall and ceiling products. The higher the NRC, the better the product is at soaking up the sound.

Performance Indices: Noise Reduction Coefficient (NRC) results represent the absorption coefficients measured at the one third octave bands at 125, 250, 500, 1000, 2000 and 4000 Hz rounded to the nearest 0.05. Acoustic testing has been performed according to the methods mentioned above. Customization of installation of the product could alter the results. Sound Absorption Average (SAA) indicates the absorption coefficient average for the twelve one-third octave bands ranging between 200 and 2500 Hz.

 For questions or additional product information, visit [acoufelt.com](https://www.acoufelt.com) or call **800.966.8557**.

Blox, Deep Ceiling Clouds | December 2025

FIXTURE TYPE _____

PROJECT NAME _____

LOCATION _____



Uniform Static White (Indoor)

INDOOR WHITE LIGHT TAPE



I Description

Our Uniform Static White series provides single bin, 3 step color consistency across every single output option and will never create a diode image when paired with any Kelvix channel.

I Features

- Uses U2835 Diode
- Create a Custom Fixture with Kelvix Channels
- 5-Year Warranty
- UL-Listed
- 3M™ Industrial Adhesive Backing
- For Use with 24V Power Supplies
- Dimmable using Kelvix Power Supplies

I Series Spec

Series	UNI-WL
Temp/Colors*	1800K–6500K
Input Voltage	24V DC/Constant Voltage
Beam Spread	120°
CRI	Ra 90+, R9 70+
Diode	2835
Diode Pitch	240 LED/m
Binning Tolerance*	ANSI 3Step
Cut Intervals	1.31" (33.3mm)
Dimensions	0.47" (12.0mm) × 0.07" (1.8mm)
Operating Temp.	-4°F (-20°C) to 140°F (60°C)
Storage Temp.	-4°F (-20°C) to 158°F (70°C)

I Product Code Builder

Series	Location	Output*	Temp/Color*	Voltage	Modification
UNI-WL	I			24V	NA
UNI-WL – Uniform Static White	I – Indoor	100 – 100 lm/ft 200 – 200 lm/ft 300 – 300 lm/ft 400 – 400 lm/ft 500 – 500 lm/ft 750 – 750 lm/ft 1000 – 1000 lm/ft 1250 – 1250 lm/ft 1500 – 1500 lm/ft	18K – 1800K 22K – 2200K 24K – 2400K 27K – 2700K 30K – 3000K 35K – 3500K 40K – 4000K 50K – 5000K 65K – 6500K	24V – 24V DC	NA – None
Example: UNI-WL-I-100-18K-24V-NA					

* Customizable—Consult Factory

Conforms to ANSI/UL Standard 2108
Certified to CAN/CSA Standard C22.2 NO. 250.0



I Series Data

Output (lm/ft)	UNI-WL 100	UNI-WL 200	UNI-WL 300	UNI-WL 400	UNI-WL 500	UNI-WL 750	UNI-WL 1000	UNI-WL 1250	UNI-WL 1500	
Lumens (per ft)	1800K	83	162	245	324	391	635	846	1040	1261
	2200K	91	177	267	353	425	670	894	1098	1331
	2400K	93	182	276	365	439	685	914	1123	1361
	2700K	97	189	287	379	457	704	939	1154	1399
	3000K	100	195	295	390	470	720	960	1180	1430
	3500K	103	201	304	402	485	739	986	1211	1468
	4000K	105	205	309	409	493	751	1001	1231	1492
	5000K	106	207	313	414	499	760	1013	1245	1509
	6500K	110	215	325	430	519	758	1011	1243	1506
Wattage ¹ (per ft)	0.7	1.3	2.0	2.6	3.4	4.4	5.6	7.2	8.6	
Efficiency (lm/W)	144	147	150	150	140	162	173	164	166	
Max Run Length (ft)	46	30	25	22	19	17	14	11	11	

¹Power consumption based on average wattage per foot. Refer to Power Chart on page 4 for details.

I Dimensions

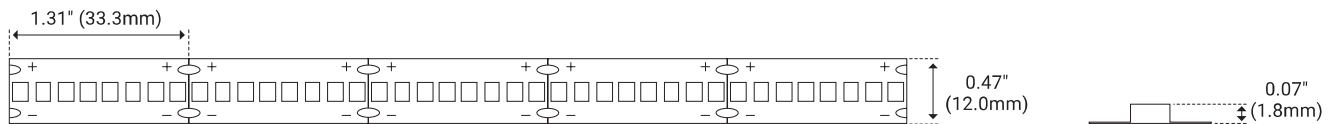



I Power Feed Accessories*

Lead



Unit Number	Length
FML-2C-1	12.00" (305.0mm)
FML-2C-2	24.00" (0.60m)
FML-2C-3	36.00" (0.91m)
FML-2C-6	72.00" (1.82m)
FML-2C-12	144.00" (3.65m)
FML-2C-15	180.00" (4.57m)
FML-2C-20	240.00" (6.09m)

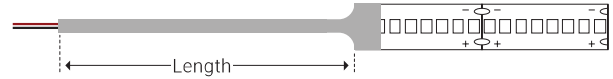

For leads on both input and output, specify 2x FML-xC-xx per run.

Lead with DC Plug



Unit Number	Length
FML-2C-DC-1-M	12.00" (305.0mm)
FML-2C-DC-1-F	12.00" (305.0mm)
FML-2C-DC-6-M	72.00" (1.82m)
FML-2C-DC-6-F	72.00" (1.82m)
FML-2C-DC-10-M	120.00" (3.04m)
FML-2C-DC-10-F	120.00" (3.04m)

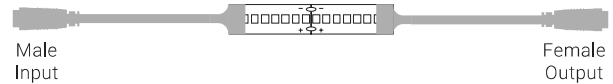
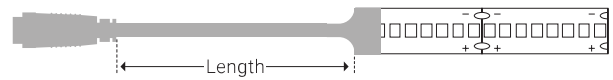

Connector



Unit Number	Length
FMC-2C-1.5I	1.50" (38.0mm)
FMC-2C-3I	3.00" (76.0mm)
FMC-2C-6I	6.00" (152.0mm)
FMC-2C-9I	9.00" (228.0mm)
FMC-2C-1	12.00" (305.0mm)
FMC-2C-2	24.00" (0.60m)



* Customizable—Consult Factory



I Power Chart

		UNI-WL-100	UNI-WL-200	UNI-WL-300	UNI-WL-400	UNI-WL-500	UNI-WL-750	UNI-WL-1000	UNI-WL-1250	UNI-WL-1500
Watts	1 ft	0.7	1.5	2.2	3	3.9	5.3	6.7	8.6	10.7
	2 ft	1.5	2.9	4.6	6.1	7.9	10.4	13	16.6	20.5
	3 ft	2.3	4.5	6.7	9	11.7	15.5	19.2	24.1	29.6
	4 ft	3.1	5.9	8.9	11.8	15.4	20.2	25	31.3	38.1
	5 ft	3.8	7.4	11	14.6	18.6	24.6	29.5	37.4	44.8
	6 ft	4.6	8.8	12.9	17.1	21.9	28.5	34.8	43.2	51.6
	7 ft	5.4	10.1	14.9	19.6	24.8	32.6	39.4	48	56.9
	8 ft	6	11.5	16.8	22.1	28	36.2	43.4	52.8	61.5
	9 ft	6.9	12.7	18.7	24.5	31.1	39.7	47.3	57.4	66.3
	10 ft	7.6	14	20.5	26.7	33.8	43.6	51.3	61.1	70.3
	11 ft	8.3	15.2	22.3	29	36.2	46.5	54.5	65.9	74.4
	12 ft	9	16.4	24.1	31.1	38.5	49.3	57.8	-	-
	13 ft	9.7	17.8	25.8	33	40.7	51.4	60.5	-	-
	14 ft	10.3	18.9	27.4	33.4	42.7	53.8	62.9	-	-
	15 ft	11	19.9	28.7	36.8	44.7	56.9	-	-	-
	16 ft	11.8	21.1	30.4	38.7	46.8	59.3	-	-	-
	17 ft	12.4	22.3	31.8	40.2	48.9	61.7	-	-	-
	18 ft	13	23.3	33.4	41.9	50.3	-	-	-	-
	19 ft	13.7	24.3	34.7	43.5	52.1	-	-	-	-
	20 ft	14.2	25.5	35.8	45	-	-	-	-	-
	21 ft	14.9	26.4	36.9	46	-	-	-	-	-
	22 ft	15.4	27.5	37.3	47.6	-	-	-	-	-
	23 ft	16.1	28.3	38	-	-	-	-	-	-
	24 ft	16.6	29.3	39	-	-	-	-	-	-
	25 ft	17.2	30.1	40.3	-	-	-	-	-	-
	26 ft	17.8	30.8	-	-	-	-	-	-	-
	27 ft	18.4	31.6	-	-	-	-	-	-	-
	28 ft	19	32.4	-	-	-	-	-	-	-
	29 ft	19.5	33.4	-	-	-	-	-	-	-
	30 ft	20.1	34.2	-	-	-	-	-	-	-
	31 ft	20.7	-	-	-	-	-	-	-	-
	32 ft	21.1	-	-	-	-	-	-	-	-
	33 ft	21.7	-	-	-	-	-	-	-	-
	34 ft	22.2	-	-	-	-	-	-	-	-
	35 ft	22.7	-	-	-	-	-	-	-	-
	36 ft	23.2	-	-	-	-	-	-	-	-
	37 ft	23.7	-	-	-	-	-	-	-	-
	38 ft	24.2	-	-	-	-	-	-	-	-
	39 ft	24.6	-	-	-	-	-	-	-	-
	40 ft	25.1	-	-	-	-	-	-	-	-
	41 ft	25.5	-	-	-	-	-	-	-	-
	42 ft	26	-	-	-	-	-	-	-	-
	43 ft	26.3	-	-	-	-	-	-	-	-
	44 ft	26.8	-	-	-	-	-	-	-	-
	45 ft	27.2	-	-	-	-	-	-	-	-
	46 ft	27.4	-	-	-	-	-	-	-	-



I Colorimetric Details (3000K)

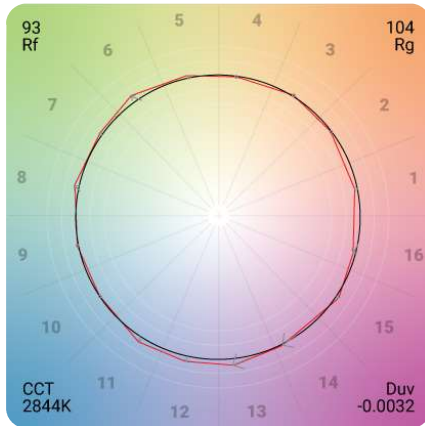

I Photometric Details (3000K)

UNI-WH 100

Mtg Height	Light Level	Beam Diameter
1.00 ft	45.79 fc	3.10 ft
2.00 ft	11.45 fc	6.20 ft
3.00 ft	5.09 fc	9.30 ft
4.00 ft	2.86 fc	12.40 ft
5.00 ft	1.83 fc	15.50 ft
6.00 ft	1.27 fc	18.60 ft
8.00 ft	0.72 fc	24.80 ft
10.00 ft	0.46 fc	31.00 ft
12.00 ft	0.32 fc	37.20 ft
15.00 ft	0.20 fc	46.50 ft

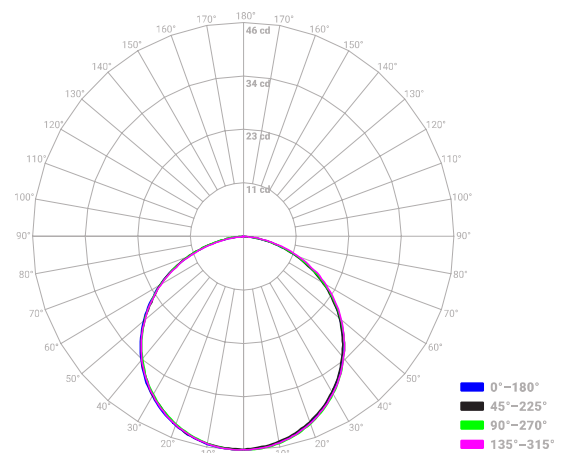

UNI-WH 200

Mtg Height	Light Level	Beam Diameter
1.00 ft	84.07 fc	3.07 ft
2.00 ft	21.02 fc	6.14 ft
3.00 ft	9.34 fc	9.21 ft
4.00 ft	5.25 fc	12.29 ft
5.00 ft	3.36 fc	15.36 ft
6.00 ft	2.34 fc	18.43 ft
8.00 ft	1.31 fc	24.57 ft
10.00 ft	0.84 fc	30.71 ft
12.00 ft	0.58 fc	36.86 ft
15.00 ft	0.37 fc	46.07 ft

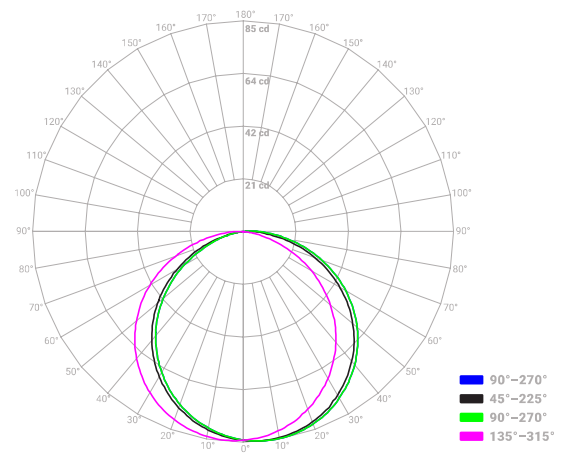



I Photometric Details (3000K)

UNI-WH 300

Mtg Height	Light Level	Beam Diameter
1.00 ft	136.34 fc	3.09 ft
2.00 ft	34.08 fc	6.18 ft
3.00 ft	15.15 fc	9.27 ft
4.00 ft	8.52 fc	12.36 ft
5.00 ft	5.45 fc	15.44 ft
6.00 ft	3.79 fc	18.53 ft
8.00 ft	2.13 fc	24.71 ft
10.00 ft	1.36 fc	30.89 ft
12.00 ft	0.95 fc	37.07 ft
15.00 ft	0.61 fc	46.33 ft

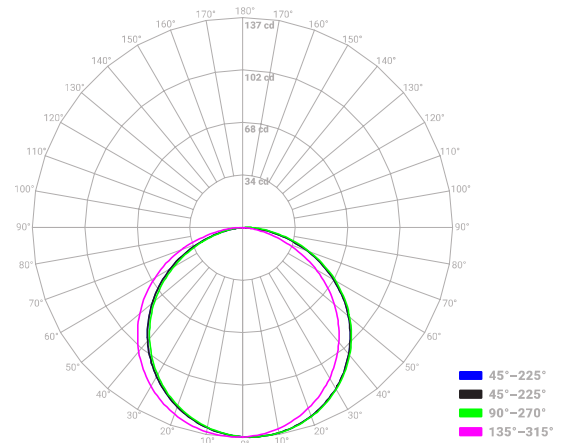

UNI-WH 400

Mtg Height	Light Level	Beam Diameter
1.00 ft	169.18 fc	3.10 ft
2.00 ft	42.30 fc	6.20 ft
3.00 ft	18.80 fc	9.29 ft
4.00 ft	10.57 fc	12.39 ft
5.00 ft	6.77 fc	15.49 ft
6.00 ft	4.70 fc	18.59 ft
8.00 ft	2.64 fc	24.78 ft
10.00 ft	1.69 fc	30.98 ft
12.00 ft	1.17 fc	37.17 ft
15.00 ft	0.75 fc	46.47 ft

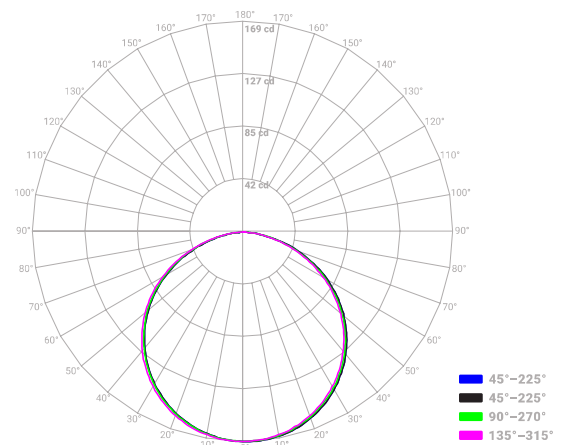

UNI-WH 500

Mtg Height	Light Level	Beam Diameter
1.00 ft	205.38 fc	3.08 ft
2.00 ft	51.35 fc	6.17 ft
3.00 ft	22.82 fc	9.25 ft
4.00 ft	12.84 fc	12.33 ft
5.00 ft	8.22 fc	15.42 ft
6.00 ft	5.71 fc	18.50 ft
8.00 ft	3.21 fc	24.67 ft
10.00 ft	2.05 fc	30.84 ft
12.00 ft	1.43 fc	37.00 ft
15.00 ft	0.91 fc	46.25 ft

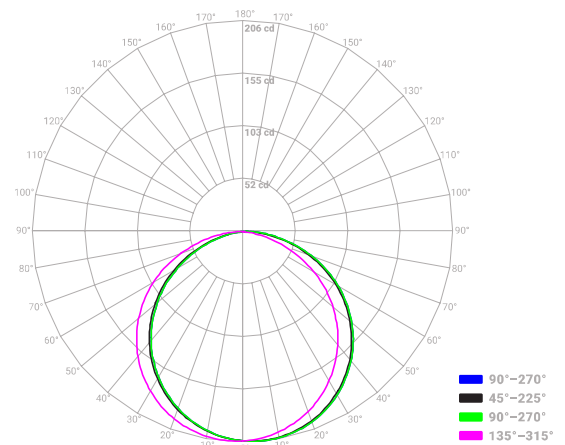



I Photometric Details (3000K)

UNI-WH 750

Mtg Height	Light Level	Beam Diameter
1.00 ft	286.47 fc	3.13 ft
2.00 ft	71.62 fc	6.25 ft
3.00 ft	31.83 fc	9.38 ft
4.00 ft	17.90 fc	12.50 ft
5.00 ft	11.46 fc	15.63 ft
6.00 ft	7.96 fc	18.75 ft
8.00 ft	4.48 fc	25.01 ft
10.00 ft	2.86 fc	31.26 ft
12.00 ft	1.99 fc	37.51 ft
15.00 ft	1.27 fc	46.89 ft

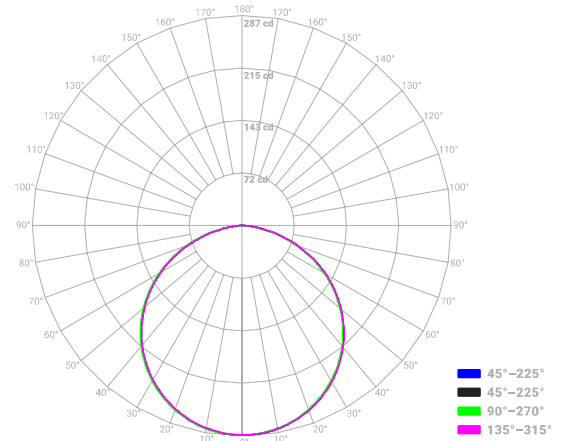

UNI-WH 1000

Mtg Height	Light Level	Beam Diameter
1.00 ft	365.22 fc	3.11 ft
2.00 ft	91.30 fc	6.23 ft
3.00 ft	40.58 fc	9.34 ft
4.00 ft	22.83 fc	12.45 ft
5.00 ft	14.61 fc	15.57 ft
6.00 ft	10.14 fc	18.68 ft
8.00 ft	5.71 fc	24.91 ft
10.00 ft	3.65 fc	31.13 ft
12.00 ft	2.54 fc	37.36 ft
15.00 ft	1.62 fc	46.70 ft

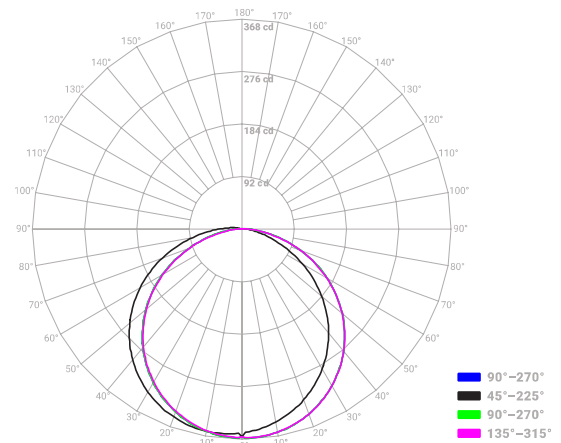

UNI-WH 1250

Mtg Height	Light Level	Beam Diameter
1.00 ft	468.98 fc	3.11 ft
2.00 ft	117.25 fc	6.23 ft
3.00 ft	52.11 fc	9.34 ft
4.00 ft	29.31 fc	12.45 ft
5.00 ft	18.76 fc	15.57 ft
6.00 ft	13.03 fc	18.68 ft
8.00 ft	7.33 fc	24.90 ft
10.00 ft	4.69 fc	31.13 ft
12.00 ft	3.26 fc	37.36 ft
15.00 ft	2.08 fc	46.70 ft

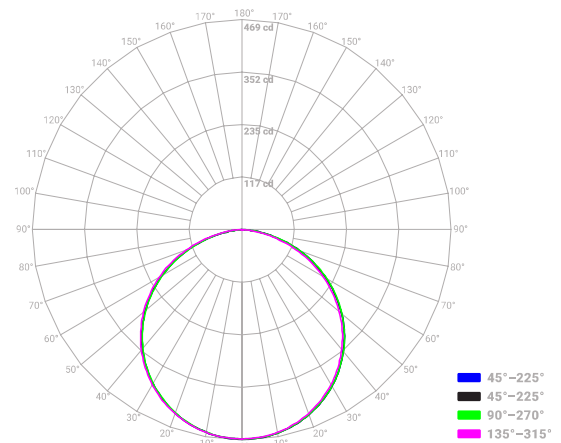



I Photometric Details (3000K)

UNI-WH 1500

Mtg Height	Light Level	Beam Diameter
1.00 ft	541.88 fc	3.13 ft
2.00 ft	135.47 fc	6.26 ft
3.00 ft	60.21 fc	9.40 ft
4.00 ft	33.87 fc	12.53 ft
5.00 ft	21.68 fc	15.66 ft
6.00 ft	15.05 fc	18.79 ft
8.00 ft	8.47 fc	25.06 ft
10.00 ft	5.42 fc	31.32 ft
12.00 ft	3.76 fc	37.59 ft
15.00 ft	2.41 fc	46.99 ft

