



Swing Ceiling Clouds

Premier Collection

The Swing ceiling clouds are shaped to resemble the black rubber swing seat from childhood. They can be easily suspended from the ceiling and add a playful touch to any space with their organic shape. At the same time, they provide targeted noise reduction. Although they look like they're hanging effortlessly, they work hard to manage the acoustic experience and ensure quiet in any space.

Specifications

Surface	Ceiling
Material	FilaSorb™ polyester felt
Thickness	1/2", 12mm (±10%)
Weight	0.49 lb./ft ² (±10%)
Standard Sizes	4" T x 24" W x 12" H 4" T x 36" W x 18" H 4" T x 48" W x 24" H Length: 24, 48" L

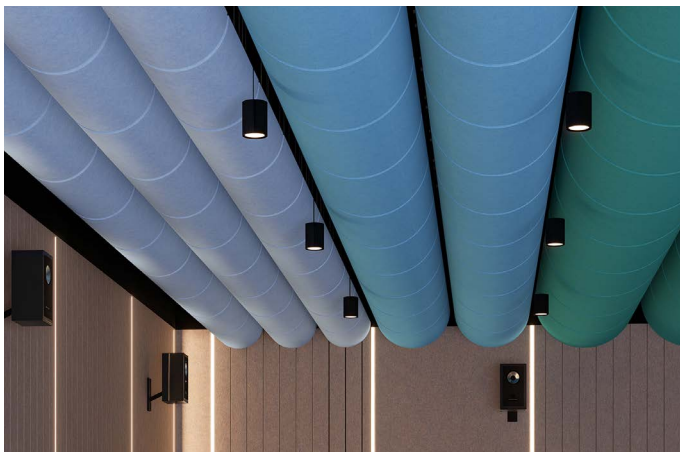

Swing Ceiling Cloud in Peacock, Azure, Periwinkle and Amethyst

Technical

NRC Rating	Pending Product Testing
Fire Test	ASTM E84, Class A Flame spread index: 15 Smoke developed index: 200
Water Sorption	ASTM C1104-2019 (A Modified) Water sorbed by weight: 0.20% (based on a 12mm thick panel)
Colorfastness	ISO 105-B02, 6-7

Details

Lead Time	3 - 6 weeks
Origin	Manufactured and assembled in the US
Warranty	Product: 20 years* Colorfastness: 20 years*

* Conditions apply

Environmental

Recycled Content	Minimum 60%
Energy	Generated using 40% solar energy
Indoor Air Quality	VOC less than/equal to 0.5mg/m ³
Recyclable	100%*
Certifications	Declare Certification - LBC Red List Free (third-party verified) SCS Global Indoor Advantage Gold

* PET is recyclable through participating partners



For questions or additional product information, visit [acoufelt.com](https://www.acoufelt.com) or call 800.966.8557.

Swing Ceiling Clouds | January 2026

Colorways

PREMIER

							
White WH12	Milkyway MI74	Ivory IV11	Pearl PE21	Valentine VA70	Quartz QU67	Stonewash ST72	Sea Salt SE57
							
Platinum PL04	Almond AL55	Pistachio PI25	Turmeric TU60	Flamingo FL61	Amethyst AM69	Periwinkle PE23	Peacock PE20
							
Metal ME03	Mushroom MU75	Celery CE65	Wheat WH68	Peach PE19	Lilac LI13	Marine MA15	Sencha SE58
							
Grey GR02	Umber UM54	Wasabi WA29	Popcorn PO26	Currant CU59	Berry BE06	Azure AZ05	Oregano OR18
							
Charcoal CH01	Walnut WA56	Eucalyptus EU71	Carrot CA08	Loganberry LO77	Granite GR62	Denim DE09	Kale KA12
							
Piano Black PI24	Slate SL27	Nori NO76	Peppercorn PE22	Shiraz SH63	Flint FL64	Midnight MI16	

Order samples at acoufelt.com/colorways

 For questions or additional product information, visit acoufelt.com or call 800.966.8557.

Swing Ceiling Clouds | January 2026

Sizes

Standard Sizes 4" T x 24" W x 12" H
4" T x 36" W x 18" H
4" T x 48" W x 24" H
Lengths: 24, 48" L

Thickness 1/2", 12mm (±10%)

Front Elevation

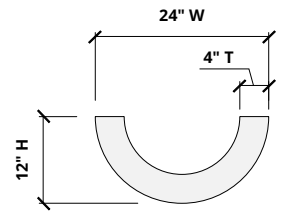
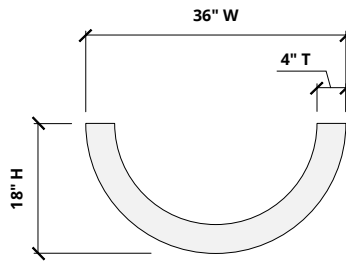
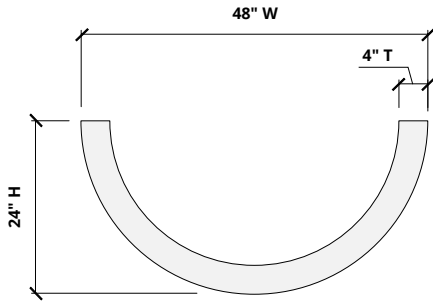

Side Elevation

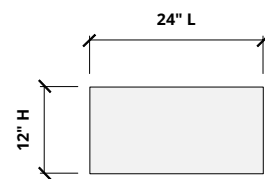
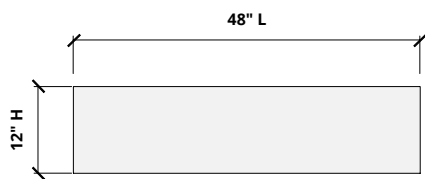
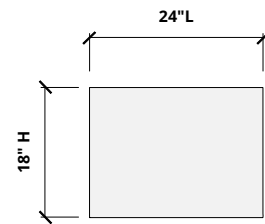
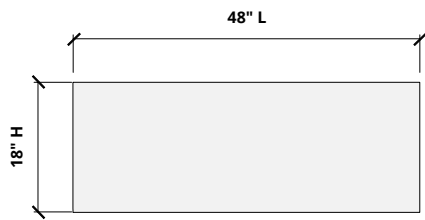
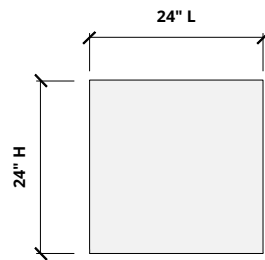
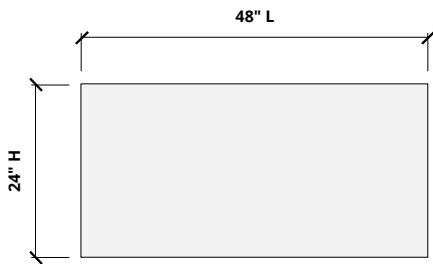

 For questions or additional product information, visit [acoufelt.com](https://www.acoufelt.com) or call 800.966.8557.

Swing Ceiling Clouds | January 2026

Hardware Spacing

24" W, L	12" on center spacing
36" W	18" on center spacing
48" W, L	24" on center spacing

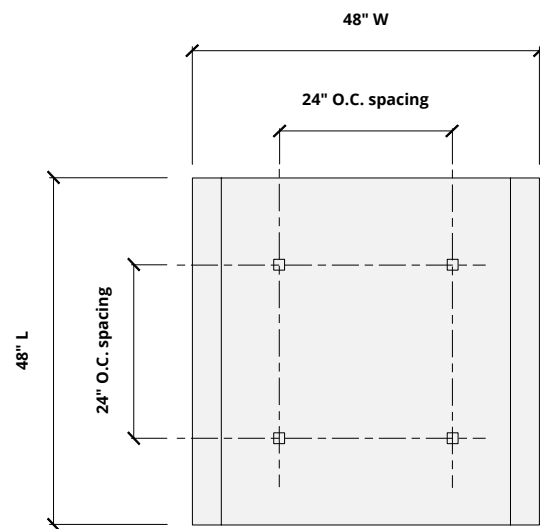
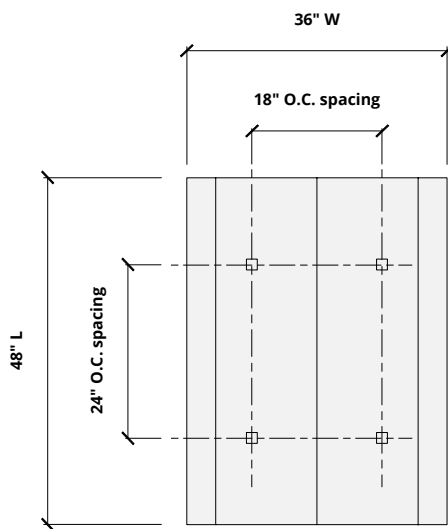
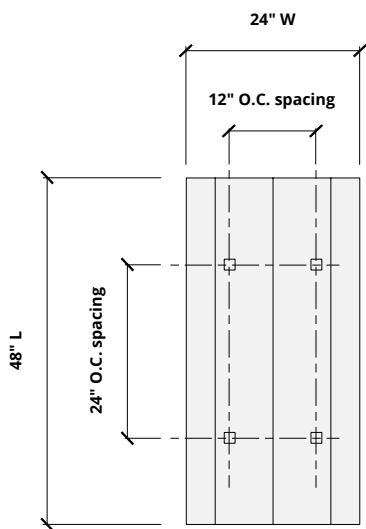
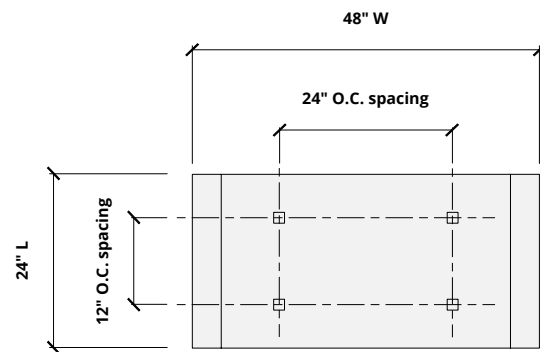
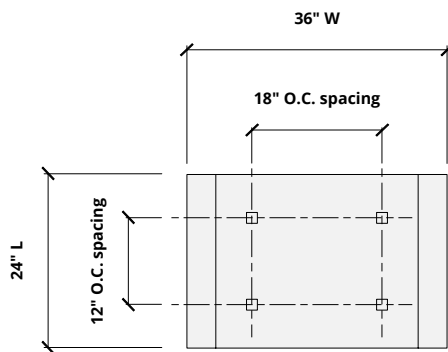
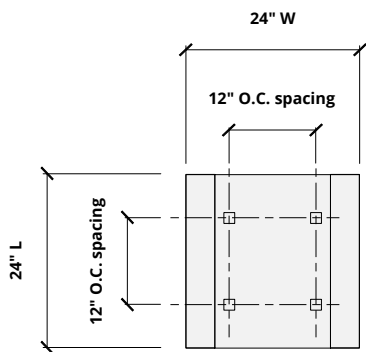

Mounting Methods

Cable

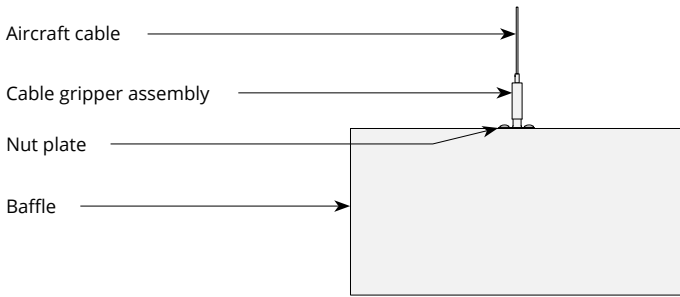

Cable to deck

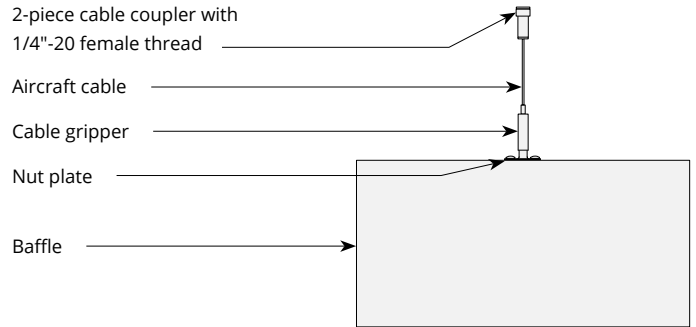

Cable to T-grid

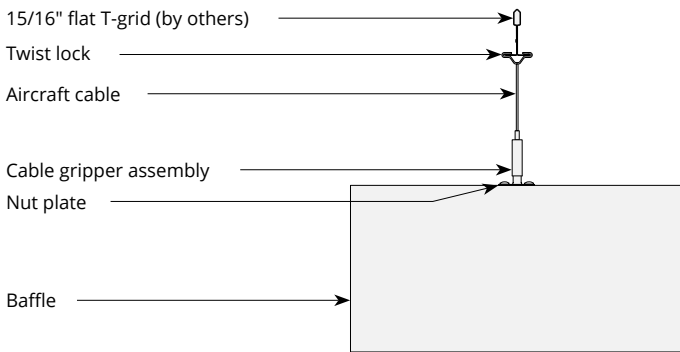

Cable to Unistrut

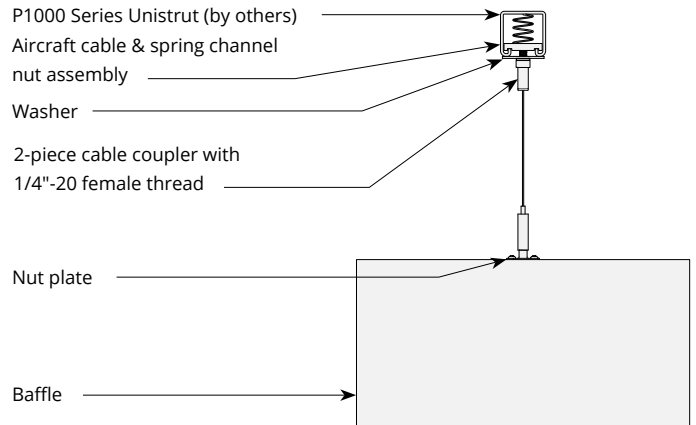

Swivel cable to deck

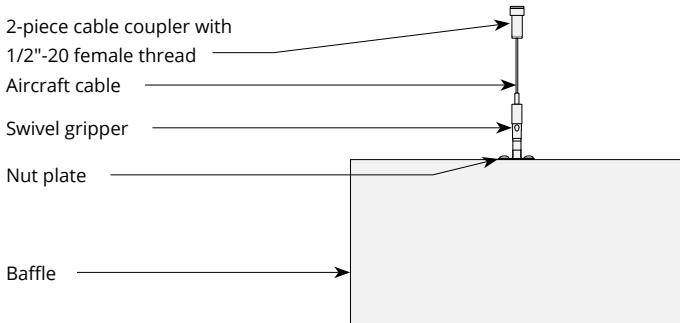

Acoustic Performance

Test Method	ISO 11654-2002
Install Method	E200, E400
Rating Method	ASTM C423-09a
Test Results	Pending Product Testing

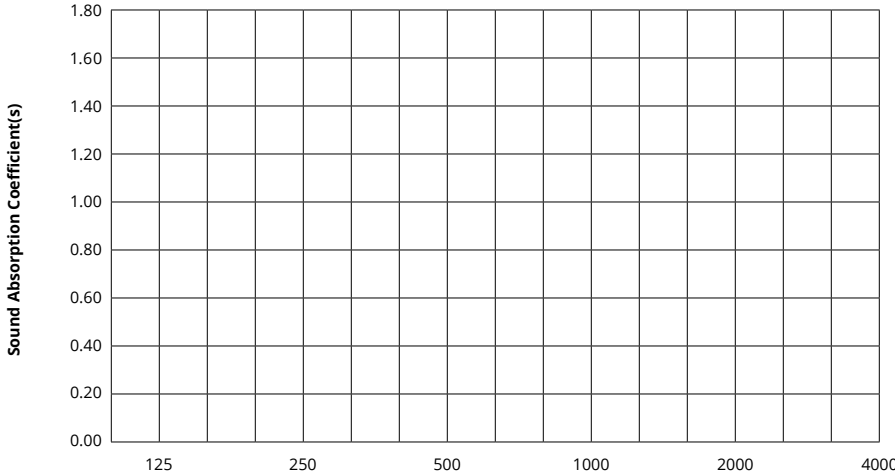

Frequency f (Hz)	125	250	500	1000	2000	4000	NRC
	Pending product testing						0.85

What is a Noise Reduction Coefficient (NRC)?

You'll find the NRC rating in the specifications of all of our products. This acronym stands for Noise Reduction Coefficient, and is expressed as a single number, a rating that describes the degree to which acoustic products can absorb sound.

You can use NRC values to understand the overall performance of our acoustic wall and ceiling products. The higher the NRC, the better the product is at soaking up the sound.

Performance Indices: Noise Reduction Coefficient (NRC) results represent the absorption coefficients measured at the one third octave bands at 125, 250, 500, 1000, 2000 and 4000 Hz rounded to the nearest 0.05. Acoustic testing has been performed according to the methods mentioned above. Customization of installation of the product could alter the results. Sound Absorption Average (SAA) indicates the absorption coefficient average for the twelve one-third octave bands ranging between 200 and 2500 Hz.

 For questions or additional product information, visit [acoufelt.com](https://www.acoufelt.com) or call **800.966.8557**.

Swing Ceiling Clouds | January 2026